

Overview

HP ProLiant ML350 Generation 9 (Gen9)

The ML350 Gen9 is the 2P premium server which delivers a class-leading combination of performance, availability, expandability, manageability, reliability and serviceability making it the choice for remote offices, growing businesses and data centers.

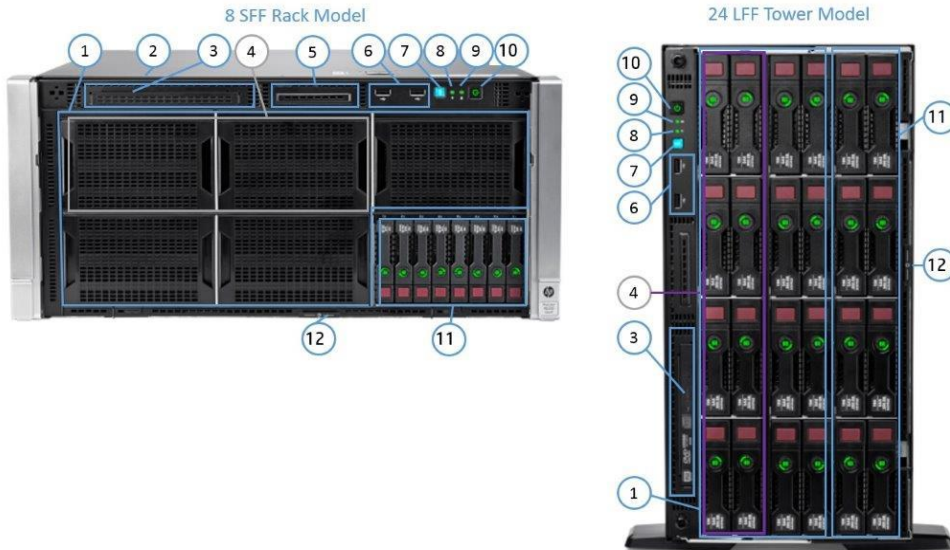

Front view details for Rack (SFF) and Tower (LFF)

1. Optional HDD cage Drive Cage Bays (Rack shown with blanks. Tower shown with 16 LFF Optional drives)
2. Quick removal access panel (shown on Rack)
3. Slim Height Drive Bay for Optional Slim Height SATA DVD-ROM or DVD RW Optical Drive (shown on Tower)
4. Media Drive Cage Bays – (SFF Rack supports two half height or one full height device; LFF Tower supports one half height device)
5. Systems Insight Display Bay for Optional SID (Rack models only)
6. Two (2) USB 2.0 connectors
7. Unit ID LED button
8. Health LED
9. NIC Activity LED
10. Power On /Standby button & system power LED button
11. Eight (8) SFF (Rack)/LFF (Tower) SAS/SATA HDD cage
12. Serial label pull tab

Overview

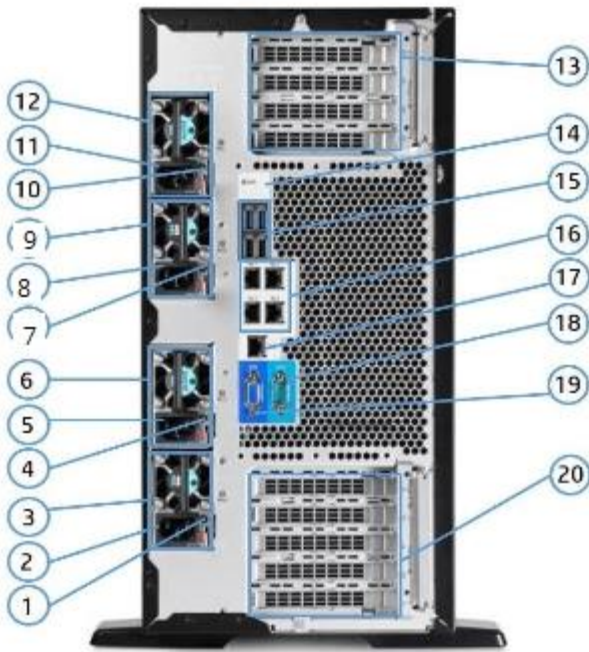

Rear View (Tower Model)

1. Power supply Power LED
2. Power supply Power connection
3. HP Flexible Slot 4 Power Supply (Optional - 500w Power Supply shown)
4. Power supply Power LED
5. Power supply Power connection
6. HP Flexible Slot 3 Power Supply (Optional - 500w Power Supply shown)
7. Power supply Power LED
8. Power supply Power connection
9. HP Flexible Slot 2 Power Supply (Optional - 500w Power Supply shown)
10. Power supply Power LED
11. Power supply Power connection
12. HP Flexible Slot 1 Power Supply (Standard Entry Model - 500w Power Supply shown)
13. PCI Slots (Slots 1-4) Slot 1 and 3 can support Optional GPU
14. Unit ID LED
15. USB 3.0 Connectors (2) top & USB 2.0 Connectors (2) bottom
16. Embedded 4 x 1GbE Network Adapter
17. Dedicated iLO Connector
18. Serial Connector
19. Video Connector
20. PCI Slots (Slots 5-9) requires Optional second processor—Slot 6 and 8 can support Optional GPU

Overview

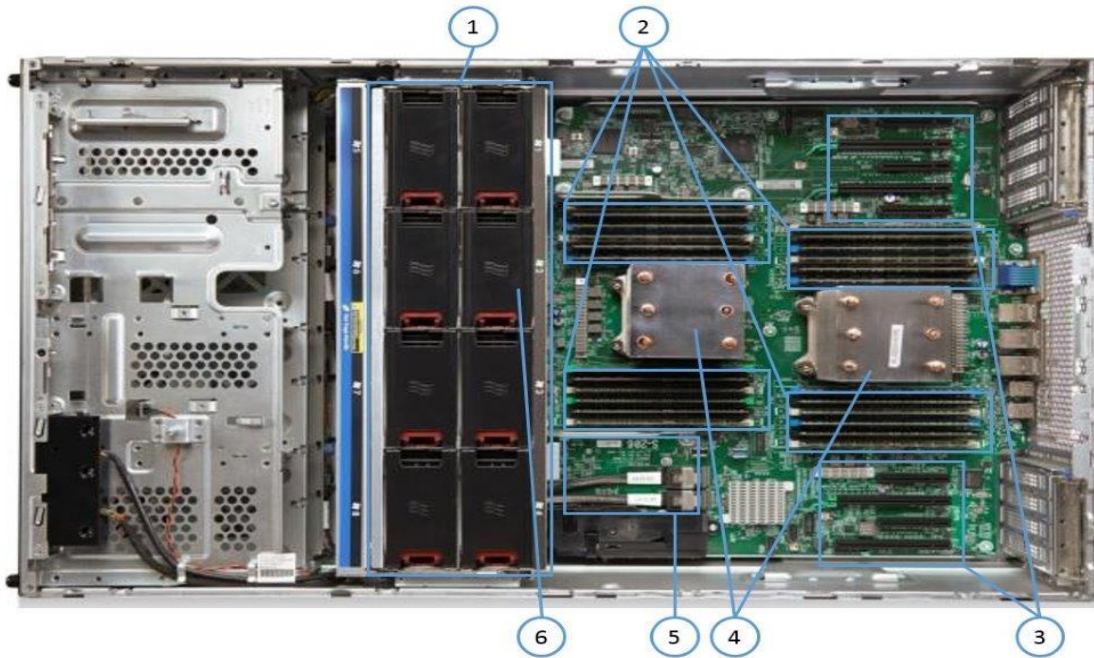

Interior View (Rack Model)

1. System fans: Three (3) fans are standard Optional Five (5) systems fans are shown.
2. Twenty four DIMM slots: DDR4 Registered (RDIMM) or Load Reduced Registered (LRDIMM) memory
3. Nine (9) PCIe expansion slots (8 PCIe Gen3 and 1 PCIe Gen2)
4. Two (2) processors and heatsinks (Second Processor is Optional)
5. Optional HP Flexible Smart Array or Smart HBA (not shown here)
6. Optional HP Smart Storage Battery is under the system fans

Standard Features

NOTE: For more information regarding Intel Xeon processors, please see the following <http://www.intel.com/xeon>.

Intel® Xeon® processor E5-2600 v3 product family is designed to deliver the best combination of performance, built-in capabilities, and cost-effectiveness. One (or two) of the following Intel® Xeon® E5-2600 v3 processors based on the model.

Processor	Model	CPU frequency	Cores	L3 Cache	Power	QPI	DDR4 Hz
One of the following depending on model	E5-2699v3	2.3GHz	18	45MB	145W	9.6GT/s	2133
	E5-2698v3	2.3GHz	16	40MB	135W	9.6GT/s	2133
	E5-2697v3	2.6GHz	14	35MB	145W	9.6GT/s	2133
	E5-2695v3	2.3GHz	14	35MB	120W	9.6GT/s	2133
	E5-2690v3	2.6GHz	12	30MB	135W	9.6GT/s	2133
	E5-2683v3	2.0GHz	14	35MB	120W	9.6GT/s	2133
	E5-2680v3	2.5GHz	12	30MB	120W	9.6GT/s	2133
	E5-2670v3	2.3GHz	12	30MB	120W	9.6GT/s	2133
	E5-2667v3	3.2GHz	8	20MB	135W	9.6GT/s	2133
	E5-2660v3	2.6GHz	10	25MB	105W	9.6GT/s	2133
	E5-2650v3	2.3GHz	10	25MB	105W	9.6GT/s	2133
	E5-2650Lv3	1.8GHz	12	30MB	65W	9.6GT/s	2133
	E5-2643v3	3.4GHz	6	20MB	135W	9.6GT/s	2133
	E5-2640v3	2.6GHz	8	20MB	90W	8.0GT/s	1866
	E5-2637v3	3.5GHz	4	15MB	135W	9.6GT/s	2133
	E5-2630v3	2.4Ghz	8	20MB	85W	8.0GT/s	1866
	E5-2630Lv3	1.8GHz	8	20MB	55W	8.0GT/s	1866
	E5-2623v3	3.0GHz	4	10MB	105W	8.0GT/s	1866
	E5-2620v3	2.4GHz	6	15MB	85W	8.0GT/s	1866
	E5-2609v3	1.9GHz	6	15MB	85W	6.4GT/s	1600
E5-2603v3	1.6GHz	6	15MB	85W	6.4GT/s	1600	

Chipset Intel® C610 Series Chipset
 Intel® E5-2600v3 Processor Family
NOTE: For more information regarding Intel® chipsets, please see the following URL:
<http://www.intel.com/products/server/chipsets/>.

On System Management Chipset HP iLO (Firmware HP iLO4 2.0) 4GB NAND
NOTE: 1GB USB user space configurable via UEFI and accessible via iLO. Read and learn more in the [iLO QuickSpecs](#).

Memory Type:
 HP SmartMemory
 DDR4 Registered (RDIMM) or Load Reduced (LRDIMM)
 DIMM Slots Available 24 (12 DIMM slots per processor, 4 channels per processor, 3 DIMMs per channel)
 Maximum Capacity (LRDIMM) 768GB (24 x 32GB LRDIMM @2133MHz)
 Maximum Capacity (RDIMM) 384GB (24 x 16GB RDIMM @2133MHz)
NOTE: 64GB LRDIMMs, feature support to be available on March 2015.

Memory Protection Advanced ECC Advanced ECC uses single device data correction to detect and correct single and all multibit error that occurs within a single DRAM chip.
 Online spare Memory online spare mode detects a rank that is degrading and switches operation to the spare rank.

Expansion Slots

Standard Features

Expansion Slots #	Technology	Bus Width	Connector Width	Bus Number	Form Factor	Notes
9	PCIe 3.0	x4	x8		Full length, full height slot	For processor 2 slot
8	PCIe 3.0	x16	x16		Full length, full height slot	For processor 2 slot
7	PCIe 3.0	x4	x8		Full length, full height slot	For processor 2 slot
6	PCIe 3.0	x16	x16		Full length, full height slot	For processor 2 slot
5	PCIe 2.0	x4	x8		Half length, full height slot	For processor 2 slot
4	PCIe 3.0	x4	x8	0	Full length, full height slot	For processor 1 slot
3	PCIe 3.0	x16	x16	0	Full length, full height slot	For processor 1 slot
2	PCIe 3.0	x4	x8	0	Full length, full height slot	For processor 1 slot
1	PCIe 3.0	x8	x16	0	Full length, full height slot	For processor 1 slot

NOTE: Bus number - Default bus assignment (in decimal). Inserting cards with PCI bridges may alter the actual bus assignment number.

NOTE: Nine total expansion slots. Three PCIe 3.0 x16 (x16 speed); One PCIe 3.0 x16 (x8 speed); Four PCIe 3.0 x8 (x4 speed); One PCIe 2.0 x8 (x4 speed).

Storage Controller	Entry Models	HP Dynamic Smart Array B140i
One of the following depending on model	Base Models	HP Flexible Smart Array P440ar/2GB
	Performance Models	HP Flexible Smart Array P440ar/2GB

Internal Storage Devices	Optical Drive	Optional SATA 9.5mm DVD-ROM Optical Drive Optional SATA 9.5mm DVD RW Optical Drive NOTE: Optical is optional in entry, base and performance models.
One of the following depending on model	Hard Drives	None ship standard
	Hard Drive Bays	(8) Hot plug SFF SAS/SATA HDD bays; upgradable to (48) (8) Hot Plug LFF SAS/SATA HDD Bays; upgradable to (24) NOTE: All Pre-configured Models come populated with some hard drive blanks installed. Should the customer need additional hard drive blanks, they can order more using either P/N 666987-B21: HP SFF HDD Blank Kit or P/N 666986-B21: HP LFF HDD Blank Kit. These part numbers for single HDD blanks below are also provided should the customer require replacement HDD blanks for their server.

Maximum Internal Storage	CAPACITY	CONFIGURATION
One of the following depending on model	Hot Plug LFF SAS	24 x 6TB
	Hot Plug LFF SATA	24 x 6TB
	Hot Plug SFF SAS	48 x 1.2TB
	Hot Plug SFF SATA	48 x 1TB
	Hot Plug SFF SATA SSD	48 x 1.6TB
	Hot Plug SFF SAS SSD	48 x 1.6TB
	Hot Plug LFF SATA SSD	24 x 1.6TB

Power Supply	HP 500W Flex Slot Platinum Hot Plug Power Supply
One of the following depending on model	HP 800W Flex Slot Platinum Hot Plug Power Supply
	HP 1400W Flex Slot Platinum Plus Hot Plug Power Supply
	HP Flexible Slot (Flex Slot) Power Supplies share a common electrical and physical design that allows for hot plug, tool-less installation into HP ProLiant Gen9 Performance Servers. Flex Slot power supplies are certified for high-efficiency operation and offer multiple power output options, allowing users to "right-size" a power supply for

Standard Features

specific server configurations. This flexibility helps to reduce power waste, lower overall energy costs, and avoid "trapped" power capacity in the data center.

All pre-configured servers ship with a standard 6-foot IEC C-13/C-14 jumper cord (A0K02A). This jumper cord is also included with each standard AC power supply option kit. If a different power cord is required, please check the [ProLiant Power Cables](#) web page.

To review the power requirements for your selected system, please use the HP Power Advisor Tool located at <http://www.hp.com/go/hppoweradvisor>.

Power specifications and technical content for all HP Server power supplies can be found at <http://www.hp.com/go/proliant/powersupply>.

System Fans		Non-redundant	Redundant
One of the following depending on model	1P model	3 fans	6 fans
	NOTE: Fan Redundancy is standard in performance model. Option (725878-B21 includes four fans and PCIe baffles are required for fan redundant kit.		
	2P model	4 fans	8 fans

Interfaces		
	Serial	1
	Video	1 (rear)
	Network RJ-45 (Ethernet)	4
	HP iLO Remote Management Network Port	1 Gb Dedicated
	SD Slot	1 (internal)
	NOTE: The Micro-SD slot is not a hot-pluggable device. Customers should not attempt to plug a Micro-SD card into the Micro-SD slot while the server is powered.	
	USB 2.0 Ports	5 (2 front, 2 rear, 1 internal)
	USB 3.0	3 (2 rear, 1 internal)

Operating Systems and Virtualization Software Support for ProLiant Servers	
	Microsoft Windows Server Canonical Ubuntu Red Hat Enterprise Linux (RHEL) SUSE Linux Enterprise Server (SLES) VMware Citrix XenServer
	NOTE: For more information on HP's Certified and Supported ProLiant Servers for OS and Virtualization Software and latest listing of software drivers available for your server, please visit our Support Matrix at: http://www.hp.com/go/ossupport and our driver download page http://www.hp.com/support/ML350Gen9 .

Upgradeability	
	Upgradable for two processors (Up to 18 Cores) NOTE: Total 4, 6, 8, 10, 12, 14, 16, 18 cores. Up to 24 DIMM slots available for higher Memory capacity Up to 48 SFF Hard Drive Bays; Or 24 LFF Hard Drive Bays 8 PCIe 3.0 and 1 PCIe 2.0 I/O slots for additional communications and storage expansion Redundant Power Supply and Redundant Fans Optional optical drive (up to 1) Optional System Insight Display NOTE: Rack model only.

Industry Standard Compliance	
	ACPI 2.0b Compliant PCIe 3.0 Compliant PXE Support WOL Support Novell Certified IPMI 2.0, SMASH CLP, DCMI 1.0 compliant

Standard Features

Microsoft® Logo certifications
 USB 3.0 Support
 SMBIOS 2.7.1
 ASHRAE A3/A4
 Energy Star

Graphics

16 bit color: maximum resolution of 1600 x 1200
 Integrated Matrox G200 video standard
 32 bit color: maximum resolution of 1280 x 1024

- 16 MB Flash
- 256 MB DDR3

**HP Server
 UEFI/Legacy ROM**

HP Server UEFI /Legacy ROM

Unified Extensible Firmware Interface (UEFI) is an industry standard that provides better manageability and more secured configuration while interacting with your server at boot time. HP ProLiant Gen9 platform defaults to UEFI and can be factory or field configured for Legacy BIOS Boot Mode.

NOTE: The UEFI System Utilities function is analogous to the HP ROM-Based Setup Utility (RBSU) of legacy BIOS. For more information, please visit <http://www.hp.com/go/proliantuefi/docs>.

UEFI enables numerous new capabilities specific to HP ProLiant servers such as:

- Secure Boot
- Operating system specific functionality
- Support for > 2.2 TB (using GPT) boot drives
- USB 3.0 Stack
- Embedded UEFI Shell
- Mass Configuration Deployment Tool using HP RESTful API.
- PXE boot support for IPv6 networks
- Boot support for option cards that only support a UEFI option ROM

For more information please visit <http://www.hp.com/go/proliant/uefi>.

NOTE: For UEFI Boot Mode, boot environment and OS image installations should be configured properly to support UEFI.

NOTE: HP UEFI FIO Setting (758959-B22) can be selected to configure the system in Legacy mode in the factory.

Form Factor Tower or Rack (5U)

**Embedded
 Management**

HP Integrated Lights-Out (HP iLO) Monitor your servers for ongoing management, service alerting, reporting and remote management with iLO. Learn more at <http://www.hp.com/go/ilo>.

UEFI Configure and boot your servers securely with industry standard Unified Extensible Firmware Interface (UEFI). Learn more at <http://www.hp.com/go/ProLiant/uefi>.

HP RESTful API RESTful API is an application programming interface. RESTful Web Service API served by iLO's web server. Learn more at <http://www.hp.com/go/restfulapi>.

Intelligent Provisioning Provision servers by discovering and deploying 1 to few servers with Intelligent Provisioning. Learn more at <http://www.hp.com/go/intelligentprovisioning>.

Embedded Remote Support HP's embedded remote support, used with Insight Online direct connect or HP Insight Remote Support, allows HP ProLiant servers to transmit hardware events directly to HP or an HP Authorized Partner for automated phone home support. Learn more at <http://www.hp.com/go/insightonline/info>.

Standard Features

Server utilities	HP Smart Update	Optimize firmware and driver updates with HP Smart Update solutions. Learn more at http://www.hp.com/go/smartupdate .
	HP Systems Insight Manager (HP SIM)	HP SIM allows you to monitor the health of your HP ProLiant Servers and HP Integrity Servers, and also provides you with basic support for non-HP servers. HP SIM also integrates with HP SUM to provide quick and seamless firmware updates. Learn more at http://www.hp.com/go/sim .
	HP OneView Standard	HP OneView Standard can inventory, monitor, alert, and report on your G6, G7, Gen8, and Gen9 servers, while using the HP OneView user interface. Annual support is optionally available. Learn more at http://www.hp.com/go/oneview .
	Scripting Tool Kit and Windows PowerShell	Provision 1 to many servers using your own scripts to discover and deploy them with HP Scripting Tool Kit for Windows and Linux or HP Scripting Tools for Windows PowerShell. Learn more at http://www.hp.com/go/ProLiantSTK or http://www.hp.com/go/powershell .
	HP RESTful Interface Tool	HP RESTful Interface tool is a scripting tool to provision servers using RESTful API Interface to discover and deploy servers at scale. Learn more at http://www.hp.com/go/restfulapi .
	HP iLO Mobile Application	Enables the ability to access, deploy, and manage your server anytime from anywhere from select smartphones and mobile devices. For additional information please visit: http://www.hp.com/go/ilo/mobileapp .
	HP Insight Online	HP Insight Online, available at no additional cost as part of your HP warranty, Care Pack or contractual support agreement with HP, is a personalized dashboard for simplified tracking of IT operations and support information from anywhere, anytime. Learn more at http://www.hp.com/go/insightonline/info . NOTE: The Service Pack for ProLiant (which includes HP SUM) can be downloaded from http://www.hp.com/go/spp/download . More information can be found: http://www.hp.com/go/SmartUpdate , http://www.hp.com/go/spp and http://www.hp.com/go/hpsum .

Security	<ul style="list-style-type: none"> Power-on password Setup password Serial interface control Power switch security Administrator's password TPM 1.2 UEFI
-----------------	---

Warranty	<p>This product is covered by a global limited warranty and supported by HP Services and a worldwide network of HP Authorized Channel Partners resellers. Hardware diagnostic support and repair is available for three years from date of purchase. Support for software and initial setup is available for 90 days from date of purchase. Enhancements to warranty services are available through HP Care Pack services or customized service agreements. Hard drives have either a one year or three year warranty; refer to the specific hard drive QuickSpecs for details.</p> <p>NOTE: Server Warranty includes 3-Year Parts, 3-Year Labor, 3-Year Onsite support with next business day response. Warranty repairs may be accomplished through the use of Customer Self Repair (CSR) parts. These parts fall into two categories: 1) Mandatory CSR parts are designed for easy replacement. A travel and labor charge will result when customers decline to replace a Mandatory CSR part; 2) Optional CSR parts are also designed for easy replacement but may involve added complexity. Customers may choose to have HP replace Optional CSR parts at no charge. Additional information regarding worldwide limited warranty and technical support is available at: http://h18004.www1.hp.com/products/servers/platforms/warranty/index.html.</p>
-----------------	---

Optional Features

Embedded Management	iLO Advanced	<p>HP iLO Advanced licenses offer smart remote functionality without compromise, for all HP ProLiant servers. The license includes the full integrated remote console, virtual keyboard, video, and mouse (KVM), multi-user collaboration, console record and replay, and GUI-based and scripted virtual media and virtual folders. You can also activate the enhanced security and power management functionality. Learn more about HP iLO Advanced at http://www.hp.com/go/iloadvanced.</p>
Server Management	HP Insight Control	<p>HP Insight Control, lets you deploy, migrate, monitor, remote control, and optimize your IT infrastructure through a single, simple management console. For more information, see http://www.hp.com/go/insightcontrol.</p>
	HP OneView Advanced	<p>HP OneView Advanced is converged management that eliminates infrastructure complexity with automation simplicity. This modern architecture is designed to accelerate your IT operations across servers, storage, and network resources using software-defined approaches and automation, see http://www.hp.com/go/oneview.</p>
	HP Insight Cluster Management Utility (CMU)	<p>HP Insight Cluster Management Utility is a hyperscale-optimized management framework that includes software for the provisioning, control, performance management and monitoring of groups of nodes and infrastructure. Learn more at http://www.hp.com/go/cmu.</p>
Rack and Power Infrastructure	<p>HP Rack and Power Infrastructure products and services create highly efficient and intelligent solutions for existing or new IT data centers. HP Rack and Power infrastructure solutions – rack infrastructure, power protection and management, performance optimized data centers (PODs) – are the foundation you are looking for to help secure your long-term IT success. These products are designed to help you react to changes in the industry. They deliver efficient, easy-to-use capabilities to manage, monitor, deploy and provision infrastructure from entry to enterprise. As an industry leader, HP is uniquely positioned to address the key concerns of power, cooling, cable management and system access.</p>	
	<p>Learn more at HP Rack and Power Infrastructure.</p>	
High Performance Clusters	<p>HP Cluster Platforms are specifically engineered, factory-integrated large-scale ProLiant clusters optimized for High Performance Computing, with a choice of servers, networks and software. Operating system options include specially priced offerings for Red Hat Enterprise Linux and SUSE Linux Enterprise Server, as well as Microsoft Windows HPC Server. A Cluster Platform Configurator simplifies ordering. http://www.hp.com/go/clusters.</p>	
	<p>HP Insight Cluster Management Utility (CMU) is an HP-licensed and HP-supported suite of tools that are used for lifecycle management of hyperscale clusters of Linux ProLiant systems. CMU includes software for the centralized provisioning, management and monitoring of nodes. CMU makes the administration of clusters user friendly, efficient, and effective. http://www.hp.com/go/cmu.</p>	
	<p>NOTE: High Performance Computing (HPC) interconnect technologies are available for this server as part of the HP Cluster Platform portfolio. These high-speed InfiniBand and Gigabit interconnects are fully supported by HP when integrated within an HP cluster. Flexible, validated solutions can be defined with the help of configuration tools. http://www.hp.com/techservers/clusters/ucp/index.html.</p>	
HPC Interconnects	<p>NOTE: High Performance Computing (HPC) interconnect technologies are available for this server under the HP Cluster Platform product portfolio. These high-speed interconnects are fully supported by HP when they are part of these configure to order clusters. Solutions can be defined with a lot of flexibility with the help of configuration tools. Please visit the following URL to configure HPC Clusters with InfiniBand Interconnects: http://www.hp.com/techservers/clusters/ucp/index.html.</p>	
Storage Software	<p>Whether you need to solve a specific data protection, archiving, or storage command and control challenge, or deliver on strategic consolidation, compliance, or continuity initiatives, look no further than HP storage software. Our storage software helps you reduce costs, simplify storage infrastructure, protect vital assets and respond faster to business opportunities.</p>	
	<p>Storage software that gets the job done:</p>	
	<ul style="list-style-type: none"> Data Protection and Recovery Software Whether you're a large enterprise or a smaller business, HP data protection and recovery software will cost-effectively protect you against disaster and ensure business continuity. 	

Optional Features

- **Data Archive and Migration Software**
HP's storage software enables you to comply with data retention and retrieval requirements, improve application performance, and reduce costs by efficiently migrating infrequently accessed or less valuable data to lower cost storage.
- **Storage Resource Management Software (SRM)**
HP's storage resource management software reduces operational costs and provides the command and control foundation you need to efficiently manage and visualize your physical and virtual environments.
- **Data Replication Software**
HP offers array-based and host-based replication software for use in disaster recovery, testing, application development and reporting.
- **Storage Device Management Software**
Maximize your investment in HP storage and networking with software that enables hardware-specific configuration, performance tuning and connectivity management.
- **HP StoreVirtual VSA**
With HP StoreVirtual VSA you can use the power of virtualization to create a virtual array within your host server. Manage it as a single pool of shared storage capacity, and scale it to match your evolving needs. HP ProLiant Gen9 servers include a 3-year limited license for HP StoreVirtual VSA software with 1TB of capacity at no extra cost. Simply select to install HP StoreVirtual VSA software during server setup within Intelligent Provisioning. More information, instructional videos, and free console management software are available at <http://www.hp.com/go/vsa1TB>.

NOTE: For more information about Storage Software including QuickSpecs, please see: <http://www.hp.com/go/storage/software>.

One Config Simple (SCE)

SCE is a guided self-service tool to help sales and non-technical people provide customers with initial configurations in 3 to 5 minutes. You may then send the configuration on for configuration help, or use in your existing ordering processes. If you require "custom" rack configuration or configuration for products not available in SCE, please contact HP's Customer Business Center or an Authorized Partner for assistance. <http://www.hp.com/products/configurator>.

Service and Support

Service and Support **HP Technology Services for Industry Standard Servers**

HP Technology Services delivers confidence, reduces risk and helps customers realize agility and stability. Connect to HP to help prevent problems and solve issues faster. Our support technology lets you to tap into the knowledge of millions of devices and thousands of experts to stay informed and in control, anywhere, any time.

Protect your business beyond warranty with HP Care Pack Services

HP Care Pack Services enable you to order the right service level, length of coverage and response time as you purchase your new server, giving you full entitlement for the term you select.

Optimized Care **Supports maintaining servers at optimum performance availability****HP Proactive Care with 24x7 coverage, three year Care Pack Service**

HP Proactive Care helps prevent problems and stabilize IT by utilizing secure, real-time, predictive analytics and proactive consultations when your products are connected to HP. This Care Pack Service combines three years' proactive reporting and advice with our 24x7 coverage and enhanced escalation management, four hour hardware response time and two hour call back for software questions on leading industry standard software running on your HP ProLiant server. <http://h20195.www2.hp.com/v2/GetPDF.aspx/4AA3-8855ENW.pdf>

Standard Care Package **Supports maintaining high level of server availability****Foundation Care 24x7, three-year Care Pack Service**

HP Foundation Care 24x7 connects you to HP 24 hours a day, seven days a week for assistance on resolving issues. Hardware onsite response within four hours if needed; collaborative software included in this Care Pack service provides troubleshooting assistance on industry leading software running on your HP server. Simplify your support experience and make HP your first call for hardware or software questions.

<http://h20195.www2.hp.com/V2/GetDocument.aspx?docname=4AA4-8876ENW&cc=us&lc=en>

Related Services **HP ProLiant Server Hardware Installation**

Provides for the basic hardware installation of HP branded servers, storage devices and networking options to assist you in bringing your new hardware into operation in a timely and professional manner.

<http://h20195.www2.hp.com/V2/GetPDF.aspx/5981-9356EN.pdf>

Factory Express for Servers and storage

HP Factory Express offers configuration, customization, integration and deployment services for HP servers and storage products. Customers can choose how their factory solutions are built, tested, integrated, shipped and deployed. For more information on Factory Express services for your specific server model please contact your sales representative or go to: <http://www.hp.com/go/factory-express>.

Data Privacy Services

Protect your data through better media management. HP Data privacy services help manage and protect sensitive data to reduce the risk of unauthorized access to private information and help meet compliance requirements. Our retention services allow you to keep drives and other devices upon failure, our removal services provide convenient data sanitization and our recovery services allow you to safely retire IT assets and capture any remaining value from the hardware. www.hp.com/services/dataprivacy

Additional HP Care Pack services can be found at: <http://www.hp.com/go/cpc>

Get connected to HP to improve your support experience Prevent problems with innovative, automated monitoring tools and proactive services. Combining Proactive Care Services with our remote support technology such as Insight Online provides you with expert advice and personalized, cloud-based automated IT support, helping to prevent unplanned down time and solve problems quickly. For more information, visit: <http://www.hp.com/go/proactiveinsightexperience>

HP Support Center Personalized online support portal with access to information, tools and experts to support HP business products. Submit support cases online, chat with HP experts, access support resources or collaborate with peers. Learn more <http://www.hp.com/go/hpsc>

HP's Support Center Mobile App** allows you to resolve issues yourself or quickly connect to an agent for live support. Now, you can get access to personalized IT support anywhere, anytime. HP Insight Remote Support and HP Support Center are available at no additional cost with a HP warranty, HP Care Pack or HP contractual support agreement.

Service and Support

** HP Support Center Mobile App is subject to local availability.

Parts and Materials HP will provide HP-supported replacement parts and materials necessary to maintain the covered hardware product in operating condition, including parts and materials for available and recommended engineering improvements.

Parts and components that have reached their maximum supported lifetime and/or the maximum usage limitations as set forth in the manufacturer's operating manual, product quick-specs, or the technical product data sheet will not be provided, repaired, or replaced as part of these services.

The defective media retention service feature option applies only to Disk or eligible SSD/Flash Drives replaced by HP due to malfunction.

For more information To learn more on HP ProLiant servers, please contact your HP sales representative or HP Authorized Channel Partner or visit: <http://www.hp.com/services/proliant>

Pre-configured Models

For the Standard Features shipped in the "Factory Integrated Models", please see the "Configuration Information - Factory Integrated Models" section.

1. Pre-configured models ship with the configurations below. Options can be selected from the Core or Additional options section of this QuickSpecs.
2. HP does not allow factory integration of options into pre-configured models. Any additional options purchased will be shipped separately.
3. If you desire a custom configuration please see "Configuration Information - Factory Integrated Models" section of this QuickSpecs.

NOTE: All Pre-configured Models come populated with some hard drive blanks installed. Should the customer need additional hard drive blanks, they can order more using either P/N 666987-B21: HP SFF Hard Drive Blank Kit or P/N 666986-B21: HP LFF Hard Drive Blank Kit.

NOTE: All pre-configured servers ship with a standard 6-foot IEC C-13/C-14 jumper cord (AOK02A). This jumper cord is also included with each standard AC power supply option kit. If a different power cord is required, please check the [ProLiant Power Cables](#) web page.

Caution: HP recommends that a minimum of two people are required for all Rack Server installations. Please refer to your installation instructions for proper tools and number of people to use for any installation.

	Entry Models	Base Models
[SKU Number]	765819-001	765820-001
Model Name	HP ProLiant ML350 Gen9 E5-2609v3 8GB-R B140i 8LFF 500W PS Entry Tower Server	HP ProLiant ML350 Gen9 E5-2620v3 16GB-R P440ar 8SFF 500W PS Base Tower Server
Processor	Intel® Xeon® E5-2609v3	Intel® Xeon® E5-2620v3
Number of Processors	One	
Memory	8GB (1x8GB Registered DIMMs, 2133 MHz)	16GB (1x16GB Registered DIMMs, 2133 MHz)
Network Controller	HP Embedded 1Gb Ethernet 4-port 331i Adapter	
Storage Controller	HP Dynamic Smart Array B140i	HP Smart Array P440ar/2G Controller
Hard Drive	None ship standard; includes 6 LFF hard drive blanks	None ship standard; includes 6 SFF hard drive blanks
Internal Storage	8 LFF HDD Bays (upgradable to 24)	(8) Hot plug SFF SAS/SATA HDD bays; upgradable to (48)
Optical Drive Bay	1; (Optional: DVD-ROM, DVD-RW)	
Optical Drive	Optional Slim Optical Bay (SATA DVD-RW/ROM Optical Drive)	
PCI-Express Slots	9 PCIe slots	
Power Supply	(1) HP 500W Flex Slot Platinum Power Supply	
Fans	3 hot plug fans, non redundant	
Management	iLO Management (standard), Intelligent Provisioning (standard), iLO Advanced (optional), Insight Control (optional)	
Form Factor	Tower (5U)	
Warranty	Server Warranty includes 3-Year Parts, 3-Year Labor, 3-Year Onsite support with next business day response	

	Energy Star Models	Performance Models
[SKU Number]	765821-001	765822-001
Model Name	HP ProLiant ML350 Gen9 2xE5-2630v3 2P 32GB-R P440ar 8SFF 2x800W PS ES Rack Server	HP ProLiant ML350 Gen9 2xE5-2650v3 2P 32GB-R P440ar 8SFF 2x800W PS ES Tower Server
Processor	Intel® Xeon® E5-2630v3	Intel® Xeon® E5-2650v3
Number of Processors	Two	
Memory	32GB (2x16GB Registered DIMMs, 2133 MHz)	
Network Controller	HP Embedded 1Gb Ethernet 4-port 331i Adapter	
Storage Controller	HP Smart Array P440ar/2G Controller	
Hard Drive	None ship standard; includes 6 SFF hard drive blanks	
Internal Storage	(8) Hot plug SFF SAS/SATA HDD bays; upgradable to (48)	
Optical Drive Bay	1; (Optional: DVD-ROM, DVD-RW)	Optional Slim Optical Bay (SATA DVD-RW/ROM Optical Drive)
Optical Drive	Optional Slim Optical Bay (SATA DVD-RW/ROM Optical Drive)	
PCI-Express Slots	9 PCIe slots	
Power Supply	(2) HP 800W Flex Slot Platinum Power Supply	

Pre-configured Models

Fans	4 hot plug fans, redundant	
Management	iLO Management (standard), Intelligent Provisioning (standard), iLO Advanced (optional), Insight Control (optional)	
Energy Star	Meets Energy Star requirements	
Accessories	Rack Kit included	
Form Factor	Rack (5U), HP Easy Install Rails	Tower (5U)
Warranty	Server Warranty includes 3-Year Parts, 3-Year Labor, 3-Year Onsite support with next business day response	

Configuration Information - Factory Integrated Models

This section lists some of the steps required to configure a Factory Integrated Model. To ensure only valid configurations are ordered, HP recommends the use of an HP approved configurator. Contact your local sales representative for information on configurable product offerings and requirements.

1. Factory Integrated Models must start with a CTO Server.
2. FIO indicates that this option is only available as a factory installable option.
3. All Factory Integrated Models will be populated with sufficient hard drive blanks based on the number of initial hard drives ordered with the server.
4. Some options may not be integrated at the factory. Contact your local sales representative for additional information.

Step 1: Base Configuration (choose one of the following configurable models)

[Chassis]	HP ProLiant ML350 Gen9 Hot Plug 8SFF Configure-to-order Rack Server	HP ProLiant ML350 Gen9 Hot Plug 8SFF Configure-to-order Tower Server	HP ProLiant ML350 Gen9 Hot Plug 8LFF Configure-to-order Tower Server
SKU Number	754534-B21	754536-B21	754537-B21
Processor	2 (optional) x HP Smart Socket Guides		
DIMMSlots	24 DIMM slots for RDIMM, LRDIMM DDR4 Memory		
Storage Controller	HP Dynamic Smart Array B140i		
PCIe	9 Standard (8 FH/FL, 1 FH/HL)		
Drive Cage	8SFF Hot Plug	8LFF Hot Plug	
Network Controller	HP Embedded 1Gb Ethernet 4-port 331i Adapter		
Fans	3 hot plug fans, non redundant		
Management	iLO Management (standard), Intelligent Provisioning (standard), iLO Advanced (optional), Insight Control (optional)		
USB	2 front, 2 internal, 4 rear		

Step 2: Choose Required Options (only one of the following from each list unless otherwise noted)

HP Processors

Entry Processors- E5-2600v3 series Processors

HP ML350 Gen9 Intel® Xeon® E5-2609v3 (1.9GHz/6-core/15MB/85W) FIO Processor Kit	726661-L21
HP ML350 Gen9 Intel® Xeon® E5-2609\3v3 (1.6GHz/6-core/15MB/85W) FIO Processor Kit	726664-L21

Base Processors- E5-2600v3 series Processors

HP ML350 Gen9 Intel® Xeon® E5-2640v3 (2.6GHz/8-core/20MB/90W) FIO Processor Kit	726651-L21
HP ML350 Gen9 Intel® Xeon® E5-2630v3 (2.4GHz/8-core/20MB/85W) FIO Processor Kit	726654-L21
HP ML350 Gen9 Intel® Xeon® E5-2620v3 (2.4GHz/6-core/15MB/85W) FIO Processor Kit	726658-L21
HP ML350 Gen9 Intel® Xeon® E5-2630Lv3 (1.8GHz/8-core/20MB/55W) FIO Processor Kit	726671-L21
HP ML350 Gen9 Intel® Xeon® E5-2623v3 (3GHz/4-core/10MB/105W) FIO Processor Kit	779834-L21
HP ML350 Gen9 Intel® Xeon® E5-2637v3 (3.5GHz/4-core/10MB/135W) FIO Processor Kit	726686-L21

Performance Processors- E5-2600v3 series Processors

HP ML350 Gen9 Intel® Xeon® E5-2690v3 (2.6GHz/12-core/30MB/135W) FIO Processor Kit	726636-L21
HP ML350 Gen9 Intel® Xeon® E5-2680v3 (2.5GHz/12-core/30MB/120W) FIO Processor Kit	726639-L21
HP ML350 Gen9 Intel® Xeon® E5-2670v3 (2.3GHz/12-core/30MB/120W) FIO Processor Kit	726642-L21
HP ML350 Gen9 Intel® Xeon® E5-2660v3 (2.6GHz/10-core/25MB/105W) FIO Processor Kit	726645-L21
HP ML350 Gen9 Intel® Xeon® E5-2650v3 (2.3GHz/10-core/25MB/105W) FIO Processor Kit	726648-L21
HP ML350 Gen9 Intel® Xeon® E5-2650Lv3 (1.8GHz/12-core/30MB/65W) FIO Processor Kit	726668-L21
HP ML350 Gen9 Intel® Xeon® E5-2697v3 (2.6GHz/14-core/35MB/145W) FIO Processor Kit	726674-L21
HP ML350 Gen9 Intel® Xeon® E5-2695v3 (2.3GHz/14-core/35MB/120W) FIO Processor Kit	726677-L21
HP ML350 Gen9 Intel® Xeon® E5-2667v3 (3.2GHz/8-core/20MB/135W) FIO Processor Kit	726680-L21
HP ML350 Gen9 Intel® Xeon® E5-2643v3 (3.4GHz/6-core/20MB/135W) FIO Processor Kit	726683-L21
HP ML350 Gen9 Intel® Xeon® E5-2683v3 (2GHz/14-core/35MB/120W) FIO Processor Kit	765794-L21
HP ML350 Gen9 Intel® Xeon® E5-2699v3 (2.3GHz/18-core/45MB/145W) FIO Processor Kit	781828-L21
HP ML350 Gen9 Intel® Xeon® E5-2698v3 (2.3GHz/16-core/40MB/135W) FIO Processor Kit	781830-L21

NOTE: If two processors are desired, select one xxxxxx-L21 and one xxxxxx-B21.

NOTE: Up to 2 processors supported. Mixing different processor models is not supported.

Configuration Information - Factory Integrated Models

NOTE: DDR4 speed is the maximum memory speed of the processor. Actual memory speed may depend on the quantity and type of DIMMs installed.

NOTE: For the Intel® C600 Chipset E5-2600 Series, the letter preceding the model number indicates the Product Line (E3, E5, E7); 2600x v#, 2 = number of CPUs in a Node, 6 is socket/segment designation, 00 = Processor SKU, x = L for low power SKUs and v# (not yet designated) = version number.

HP Memory

NOTE: Select one or more memory from section below.

NOTE: LRDIMM, RDIMM are all distinct memory technologies and cannot be mixed within a server. The majority of ProLiant Gen9 servers support LRDIMM and RDIMM.

NOTE: HP memory from previous generation servers are not qualified or warranted with this HP ProLiant server. HP SmartMemory is required to realize the memory performance improvements and enhanced functionality listed in this document for Gen9.

NOTE: If only one processor is installed, only half of the total DIMM slots are available. When populating with two processors all DIMM slots are available.

NOTE: Kits described as LP include Low Power DIMMs. For more information on ProLiant Energy Efficient Features, see: <http://www.hp.com/go/proliant-energy-efficient>.

NOTE: Depending on the memory configuration and processor model, the memory speed may run at 2133MHz, 1866MHz, 1600MHz or 1333MHz. Please see Memory Population Table or Online Memory Configuration Tool at: <http://www.hp.com/go/ddr4config>.

Registered DIMMs (RDIMMs) for E5-2600v3 Series

HP 8GB (1x8GB) Single Rank x4 DDR4-2133 CAS-15-15-15 Registered Memory Kit	726718-B21
HP 4GB (1x4GB) Single Rank x8 DDR4-2133 CAS-15-15-15 Registered Memory Kit	726717-B21
HP 16GB (1x16GB) Dual Rank x4 DDR4-2133 CAS-15-15-15 Registered Memory Kit	726719-B21
HP 8GB (1x8GB) Dual Rank x8 DDR4-2133 CAS-15-15-15 Registered Memory Kit	759934-B21

Load Reduced DIMMs (LRDIMMs) for E5-2600v3 Series

HP 32GB (1x32GB) Quad Rank x4 DDR4-2133 CAS-15-15-15 Load Reduced Memory Kit	726722-B21
HP 16GB (1x16GB) Dual Rank x4 DDR4-2133 CAS-15-15-15 Load Reduced Memory Kit	726720-B21

HP Power Supplies

NOTE: Mixing of power supplies in the same server is not supported. All power supplies must be of the same input voltage, output rating, and efficiency rating. If non-matching power supplies are installed, you may receive an error message and/or experience operational issues with your server.

NOTE: Prior to selecting a power supply option, it is highly recommended that you review your server configuration in the HP Power Advisor tool to determine the right size power supply for your server configuration. The HP Power Advisor is located at: <http://www.hp.com/go/hppoweradvisor>.

HP Flex Slot Platinum Hot-plug Power supplies

HP 500W Flex Slot Platinum Hot Plug Power Supply Kit	720478-B21
HP 800W Flex Slot Platinum Hot Plug Power Supply Kit	720479-B21
HP 1400W Flex Slot Platinum Plus Hot Plug Power Supply Kit	720620-B21

Enablement Kit

HP ML350 Gen9 X4 Redundant Power Supply Enablement FIO Kit	725870-B21
--	------------

NOTE: If more than quantity two of 800W or 1400W Power Supplies are ordered, then X4 Redundant Power Supply Enablement FIO Kit must be selected. This kit does not support the 500W Power Supply.

Step 3: Choose Additional Factory Integratable Options

HP Storage Controllers

NOTE: The embedded B140i controller will be used as the primary controller if no controller has been selected from the list below. Embedded SATA controller can support up to 8 SATA hard drives.

HP Smart Array Controllers

HP Smart Array P440ar/2GB FBWC 12Gb 2-ports Int FIO SAS Controller	749974-B21
--	------------

NOTE: Provides support for up to 8 internal SAS/SATA drives without using a PCIe slot.

NOTE: Includes the HP Smart Storage Battery.

HP Smart Array P440/4GB FBWC 12Gb 1-port Int FIO SAS Controller	761872-B21
---	------------

NOTE: Includes the HP Smart Storage Battery.

HP Smart Array P840/4GB FBWC 12Gb 2-ports Int FIO SAS Controller	761874-B21
--	------------

NOTE: Includes the HP Smart Storage Battery.

HP Smart Host Bus Adapters

HP H240ar 12Gb 2-ports Int FIO Smart Host Bus Adapter	749976-B21
---	------------

NOTE: Provides support for up to 8 internal SAS/SATA drives without using a PCIe slot.

Configuration Information - Factory Integrated Models

	HP H240 12Gb 2-ports Int FIO Smart Host Bus Adapter	761873-B21
	Expander Kits	
	HP 12Gb SAS Expander Card for ML350 Gen9	769635-B21
	NOTE: Does not support H240ar or P440ar AROC cards. It contains three cables from expander card to HDD backplanes, and one cable from Smart Array or HBA to expander card.	
	HP ML350 Gen9 2 nd Expander FIO Kit	769637-B21
	NOTE: Cannot be selected when PN: 769635-B21 is not in order. If PN: 769637-B21 is selected, then 2 nd processor and X4 RPS Enablement FIO Kit (PN: 725870-B21) and P840 controller must also be ordered.	
	HP Cable Options	
	HP ML350 Gen9 Host Bus Adapter Mini-SAS Cable Kit	765648-B21
	NOTE: If PN: 761873-B21 is selected then this option kit must be selected; one card per kit.	
	HP ML350 Gen9 Smart Array Cable Kit	765650-B21
	NOTE: If PN: 761872-B21 or PN: 761874-B21 is selected then this option kit must be selected; one card per kit.	
	HP ML350 Gen9 Flexible Smart Array Controller Mini-SAS Cable Kit	765652-B21
	NOTE: If PN: 749974-B21 or PN: 749976-B21 is selected then this option kit must be selected.	
	HP ML350 Gen9 Mini SAS Cable FIO Kit	765654-B21
	NOTE: If no SAS Controller is selected and using B140i as primary, this option kit is required.	
BIOS Mode	HP Legacy FIO Mode Setting	758959-B22
	NOTE: If selected, then B140i will not be supported and can no longer be a primary controller therefore, SAS internal controller must be selected to be the primary controller.	
Controller State	HP FIO Enable B140i Setting	784308-B21
	NOTE: Must be selected when B140i is used as the primary controller and RAID is desired.	
	HP Mfg FIO Enable HBA Mode Setting	792962-B21
	NOTE: When selected if H240ar/H240 are used as the primary controller then RAID is not allowed.	
Embedded Management	HP iLO Advanced	
	HP Insight Control including 1yr 24x7 Support ProLiant ML/DL/BL-bundle FIO Electronic License	C6N36ABE
Rail Kits	HP ML350 Gen9 5U FIO Rail Kit	790357-B21
HP Location Discovery Services	HP ML350 Gen9 Discover Service FIO Kit	726549-B21

Step 4: Choose Additional for Factory Integration from Core and Additional Options sections below.

Caution: HP recommends that a minimum of two people are required for all Rack Server installations. Please refer to your installation instructions for proper tools and number of people to use for any installation

Core Options

NOTE: Some options may not be integrated at the factory. To ensure only valid configurations are ordered, HP recommends the use of an HP approved configurator. Contact your local sales representative for additional information.

HP Unique Options	<p>HP ML350 Gen9 8SFF Hard Drive Cage Kit NOTE: Add'l 8SFF Hard Drive Cage, allowing for up 48SFF Drive Bays. 778157-B21</p> <p>HP ML350 Gen9 8LFF Hot Plug Drive Cage Kit NOTE: Add'l 8LFF Hard Drive backplane allowing for up 24FF Drive Bays. 726547-B21</p> <p>HP ML350 Gen9 Redundant Fan Kit NOTE: Add'l 4 fans for redundancy. 725878-B21</p> <p>HP ML350 Gen9 Flexible Smart Array Controller Mini-SAS Cable Kit NOTE: Mini-SAS Cable Kit for FlexibleSmart Array Controller. 765652-B21</p> <p>HP ML350 Gen9 Smart Array Cable Kit NOTE: Mini-SAS Cable Kit for stand up P series Smart Array Card. 765650-B21</p> <p>HP ML350 Gen9 LFF Media Cage Kit NOTE: Cage for converting LFF drive bays to a media device. Supports 1*Half-Height tape storage/ Disk-Based Backup device. (RDX) 726561-B21</p> <p>HP ML350 Gen9 SFF Media Cage Kit NOTE: Cage for converting SFF drive bays to a media device. Supports 2*Half-Height/ 1*Full-Height tape storage/ Disk-Based Backup device (RDX). 726545-B21</p> <p>HP ML350 Gen9 Host Bus Adapter Mini-SAS Cable Kit NOTE: Mini-SAS Cable kit for Host Bus Adapter. 765648-B21</p> <p>HP ML350 Gen9 Graphic Card Support Kit NOTE: Cables and brackets for supporting graphic cards. 726565-B21</p> <p>HP ML350 Gen9 Tower to Rack Conversion Kit NOTE: For converting a tower model to a rack model. 726567-B21</p> <p>HP ML350 Gen9 System Insight Display Kit NOTE: For rack model only. 726563-B21</p> <p>HP 12Gb SAS Expander Card for ML350 Gen9 NOTE: The SAS Expander Card Kit supports for 1-24 HDDs, can't support embedded controller and H240ar or P440ar AROC cards. It contains three cables from expander card to HDD backplanes, and one cable from SA or HBA to expander card. Can't support tape storage/ Disk-Based Backup device. (RDX) 769635-B21</p>
--------------------------	--

HP Processors

Entry Processors - E5-2600v3 series Processors

HP ML350 Gen9 Intel® Xeon® E5-2609v3 (1.9GHz/6-core/15MB/85W) Processor Kit	726661-B21
HP ML350 Gen9 Intel® Xeon® E5-2603v3 (1.6GHz/6-core/15MB/85W) Processor Kit	726664-B21

Base Processors - E5-2600v3 series Processors

HP ML350 Gen9 Intel® Xeon® E5-2640v3 (2.6GHz/8-core/20MB/90W) Processor Kit	726651-B21
HP ML350 Gen9 Intel® Xeon® E5-2630v3 (2.4GHz/8-core/20MB/85W) Processor Kit	726654-B21
HP ML350 Gen9 Intel® Xeon® E5-2620v3 (2.4GHz/6-core/15MB/85W) Processor Kit	726658-B21
HP ML350 Gen9 Intel® Xeon® E5-2630Lv3 (1.8GHz/8-core/20MB/55W) Processor Kit	726671-B21
HP ML350 Gen9 Intel® Xeon® E5-2623v3 (3GHz/4-core/10MB/105W) Processor Kit	779834-B21
HP ML350 Gen9 Intel® Xeon® E5-2637v3 (3.5GHz/4-core/15MB/135W) Processor Kit	726686-B21

Performance Processors - E5-2600v3 series Processors

HP ML350 Gen9 Intel® Xeon® E5-2690v3 (2.6GHz/12-core/30MB/135W) Processor Kit	726636-B21
HP ML350 Gen9 Intel® Xeon® E5-2680v3 (2.5GHz/12-core/30MB/120W) Processor Kit	726639-B21
HP ML350 Gen9 Intel® Xeon® E5-2670v3 (2.3GHz/12-core/30MB/120W) Processor Kit	726642-B21
HP ML350 Gen9 Intel® Xeon® E5-2660v3 (2.6GHz/10-core/25MB/105W) Processor Kit	726645-B21
HP ML350 Gen9 Intel® Xeon® E5-2650v3 (2.3GHz/10-core/25MB/105W) Processor Kit	726648-B21
HP ML350 Gen9 Intel® Xeon® E5-2650Lv3 (1.8GHz/12-core/30MB/65W) Processor Kit	726668-B21
HP ML350 Gen9 Intel® Xeon® E5-2697v3 (2.6GHz/14-core/35MB/145W) Processor Kit	726674-B21
HP ML350 Gen9 Intel® Xeon® E5-2695v3 (2.3GHz/14-core/35MB/120W) Processor Kit	726677-B21
HP ML350 Gen9 Intel® Xeon® E5-2667v3 (3.2GHz/8-core/20MB/135W) Processor Kit	726680-B21
HP ML350 Gen9 Intel® Xeon® E5-2643v3 (3.4GHz/6-core/20MB/135W) Processor Kit	726683-B21

Core Options

HP ML350 Gen9 Intel® Xeon® E5-2683v3 (2GHz/14-core/35MB/120W) Processor Kit	765794-B21
HP ML350 Gen9 Intel® Xeon® E5-2699v3 (2.3GHz/18-core/45MB/145W) Processor Kit	781828-B21
HP ML350 Gen9 Intel® Xeon® E5-2698v3 (2.3GHz/16-core/40MB/135W) Processor Kit	781830-B21

HP Memory

Registered DIMMs (RDIMMs) for E5-2600v3 Series

HP 8GB (1x8GB) Single Rank x4 DDR4-2133 CAS-15-15-15 Registered Memory Kit	726718-B21
HP 4GB (1x4GB) Single Rank x8 DDR4-2133 CAS-15-15-15 Registered Memory Kit	726717-B21
HP 16GB (1x16GB) Dual Rank x4 DDR4-2133 CAS-15-15-15 Registered Memory Kit	726719-B21
HP 8GB (1x8GB) Dual Rank x8 DDR4-2133 CAS-15-15-15 Registered Memory Kit	759934-B21

Load Reduced DIMMs (LRDIMMs) for E5-2600v3 Series

HP 32GB (1x32GB) Quad Rank x4 DDR4-2133 CAS-15-15-15 Load Reduced Memory Kit	726722-B21
HP 16GB (1x16GB) Dual Rank x4 DDR4-2133 CAS-15-15-15 Load Reduced Memory Kit	726720-B21

HP Optical Drives

HP 9.5mm SATA DVD-ROM JackBlack Gen9 Optical Drive	726536-B21
HP 9.5mm SATA DVD-RW JackBlack G9 Optical Drive	726537-B21

HP Drives

SAS Hot Plug SFF (2.5-inch) Enterprise (ENT) Drives

HP 1.2TB 6G SAS 10K rpm SFF (2.5-inch) SC Dual Port Enterprise 3yr Warranty Hard Drive	718162-B21
HP 900GB 6G SAS 10K rpm SFF (2.5-inch) SC Enterprise 3yr Warranty Hard Drive	652589-B21
HP 600GB 12G SAS 15K rpm SFF (2.5-inch) SC Enterprise 3yr Warranty Hard Drive	759212-B21
HP 600GB 6G SAS 10K rpm SFF (2.5-inch) SC Enterprise 3yr Warranty Hard Drive	652583-B21
HP 450GB 12G SAS 15K rpm SFF (2.5-inch) SC Enterprise 3yr Warranty Hard Drive	759210-B21
HP 450GB 6G SAS 10K rpm SFF (2.5-inch) SC Enterprise 3yr Warranty Hard Drive	652572-B21
HP 300GB 12G SAS 15K rpm SFF (2.5-inch) SC Enterprise 3yr Warranty Hard Drive	759208-B21
HP 300GB 6G SAS 10K rpm SFF (2.5-inch) SC Enterprise 3yr Warranty Hard Drive	652564-B21
HP 146GB 6G SAS 15K rpm SFF (2.5-inch) SC Enterprise 3yr Warranty Hard Drive	652605-B21

SAS Hot Plug SFF (2.5-inch) Midline (MDL) Drives

HP 1TB 6G SAS 7.2K rpm SFF (2.5-inch) SC Midline 1yr Warranty Hard Drive	652749-B21
HP 500GB 6G SAS 7.2K rpm SFF (2.5-inch) SC Midline 1yr Warranty Hard Drive	652745-B21

SAS Hot Plug LFF (3.5-inch) Enterprise (ENT) Drives

HP 450GB 12G SAS 15K rpm LFF (3.5-inch) SC Converter Enterprise 3yr Warranty Hard Drive	737394-B21
HP 300GB 12G SAS 15K rpm LFF (3.5-inch) SC Converter Enterprise 3yr Warranty Hard Drive	737261-B21
HP 600GB 12G SAS 15K rpm LFF (3.5-inch) SC Converter Enterprise 3yr Warranty Hard Drive	765424-B21

SAS Hot Plug LFF (3.5-inch) Midline (MDL) Drives

HP 6TB 6G SAS 7.2K rpm LFF (3.5-inch) SC Midline 1yr Warranty Hard Drive	761477-B21
HP 4TB 6G SAS 7.2K rpm LFF (3.5-inch) SC Midline 1yr Warranty Hard Drive	695510-B21
HP 3TB 6G SAS 7.2K rpm LFF (3.5-inch) SC Midline 1yr Warranty Hard Drive	652766-B21
HP 2TB 6G SAS 7.2K rpm LFF (3.5-inch) SC Midline 1yr Warranty Hard Drive	652757-B21
HP 1TB 6G SAS 7.2K rpm LFF (3.5-inch) SC Midline 1yr Warranty Hard Drive	652753-B21

SATA Hot Plug SFF (2.5-inch) Midline (MDL) Drives

HP 1TB 6G SATA 7.2K rpm SFF (2.5-inch) SC Midline 1yr Warranty Hard Drive	655710-B21
HP 500GB 6G SATA 7.2K rpm SFF (2.5-inch) SC Midline 1yr Warranty Hard Drive	655708-B21

SATA Hot Plug LFF (3.5-inch) Midline (MDL) Drives

HP 6TB 6G SATA 7.2K rpm LFF (3.5-inch) SC Midline 1yr Warranty Hard Drive	753874-B21
HP 4TB 6G SATA 7.2k rpm LFF (3.5-inch) SC Midline 1yr Warranty Hard Drive	693687-B21
HP 3TB 6G SATA 7.2K rpm LFF (3.5-inch) SC Midline 1yr Warranty Hard Drive	628061-B21
HP 2TB 6G SATA 7.2K rpm LFF (3.5-inch) SC Midline 1yr Warranty Hard Drive	658079-B21
HP 1TB 6G SATA 7.2K rpm LFF (3.5-inch) SC Midline 1yr Warranty Hard Drive	657750-B21

Core Options

HP 500GB 6G SATA 7.2K rpm LFF (3.5-inch) SC Midline 1yr Warranty Hard Drive	658071-B21
SATA Non-Hot Plug LFF (3.5-inch) Midline (MDL) Drives	
HP ML350 Gen9 8SFF Hard Drive Cage Kit	778157-B21
12G SAS Hot Plug SFF (2.5-inch) Enterprise Performance Solid State Drives	
HP 800GB 12G SAS High Endurance SFF 2.5-in SC Enterprise Performance 3yr Wty Solid State Drive	741159-B21
HP 400GB 12G SAS High Endurance SFF 2.5-in SC Enterprise Performance 3yr Wty Solid State Drive	741155-B21
HP 200GB 12G SAS High Endurance SFF 2.5-in SC Enterprise Performance 3yr Wty Solid State Drive	741151-B21
12G SAS Hot Plug SFF (2.5-inch) Enterprise Mainstream Solid State Drives	
HP 800GB 12G SAS Mainstream Endurance SFF 2.5-in SC Enterprise Mainstream 3yr Wty Solid State Drive	741146-B21
HP 400GB 12G SAS Mainstream Endurance SFF 2.5-in SC Enterprise Mainstream 3yr Wty Solid State Drive	741142-B21
HP 200GB 12G SAS Mainstream Endurance SFF 2.5-in SC Enterprise Mainstream 3yr Wty Solid State Drive	741138-B21
12G SAS Hot Plug SFF (2.5-inch) Enterprise Value Solid State Drives	
HP 1.6TB 12G SAS Value Endurance SFF 2.5-in SC Enterprise Value 3yr Wty Solid State Drive	762263-B21
HP 800GB 12G SAS Value Endurance SFF 2.5-in SC Enterprise Value 3yr Wty Solid State Drive	762261-B21
12G SAS Hot Plug LFF (3.5-inch) Enterprise Value Solid State Drives	
HP 800GB 12G SAS Value Endurance LFF 3.5-in SC Enterprise Value 3yr Wty Solid State Drive	762270-B21
HP 1.6TB 12G SAS Value Endurance LFF 3.5-in SC Enterprise Value 3yr Wty Solid State Drive	762272-B21
6G SATA Hot Plug SFF (2.5-inch) Enterprise Mainstream Solid State Drives	
HP 800GB 6G SATA Mainstream Endurance SFF 2.5-in SC Enterprise Mainstream 3yr Wty Solid State Drive	691868-B21
HP 400GB 6G SATA Mainstream Endurance SFF 2.5-in SC Enterprise Mainstream 3yr Wty Solid State Drive	691866-B21
HP 200GB 6G SATA Mainstream Endurance SFF 2.5-in SC Enterprise Mainstream 3yr Wty Solid State Drive	691864-B21
HP 100GB 6G SATA Mainstream Endurance SFF 2.5-in SC Enterprise Mainstream 3yr Wty Solid State Drive	691862-B21
6G SATA Hot Plug SFF (2.5-inch) Enterprise Value Solid State Drives	
HP 800GB 6G SATA Value Endurance SFF 2.5-in SC Enterprise Value 3yr Wty Solid State Drive	717973-B21
HP 600GB 6G SATA Value Endurance SFF 2.5-in SC Enterprise Value 3yr Wty Solid State Drive	739898-B21
HP 480GB 6G SATA Value Endurance SFF 2.5-in SC Enterprise Value 3yr Wty Solid State Drive	717971-B21
HP 300GB 6G SATA Value Endurance SFF 2.5-in SC Enterprise Value 3yr Wty Solid State Drive	739888-B21
HP 240GB 6G SATA Value Endurance SFF 2.5-in SC Enterprise Value 3yr Wty Solid State Drive	717969-B21
HP 1.6TB 6G SATA Value Endurance SFF 2.5-in SC Enterprise Value 3yr Wty Solid State Drive	757339-B21
6G SATA Hot Plug SFF Value Endurance (2.5-inch) Enterprise Value G1 Solid State Drives	
HP 480GB 6G SATA Value Endurance SFF 2.5-in SC Enterprise Value 3yr Wty G1 Solid State Drive	756657-B21
HP 240GB 6G SATA Value Endurance SFF 2.5-in SC Enterprise Value 3yr Wty G1 Solid State Drive	756636-B21

Core Options

HP 120GB 6G SATA Value Endurance SFF 2.5-in SC Enterprise Value 3yr Wty G1 Solid State Drive	756621-B21
6G SATA Hot Plug SFF (2.5-inch) Enterprise Light G1 Solid State Drives	
HP 960GB 6G SATA Light Endurance SFF 2.5-in SC Enterprise Light 3yr Wty G1 Solid State Drive	756601-B21
6G SATA Hot Plug SFF (2.5-inch) Enterprise Boot Solid State Drives	
HP 120GB 6G SATA Value Endurance SFF 2.5-in SC Enterprise Boot 3yr Wty Solid State Drive	717965-B21
HP 80GB 6G SATA Value Endurance SFF 2.5-in SC Enterprise Boot 3yr Wty Solid State Drive	734360-B21
6G SATA Hot Plug LFF (3.5-inch) Enterprise Mainstream Solid State Drives	
HP 800GB 6G SATA Mainstream Endurance LFF 3.5-in SC Enterprise Mainstream 3yr Wty Solid State Drive	691860-B21
HP 400GB 6G SATA Mainstream Endurance LFF 3.5-in SC Enterprise Mainstream 3yr Wty Solid State Drive	691856-B21
HP 200GB 6G SATA Mainstream Endurance LFF 3.5-in SC Enterprise Mainstream 3yr Wty Solid State Drive	691854-B21
HP 100GB 6G SATA Mainstream Endurance LFF 3.5-in SC Enterprise Mainstream 3yr Wty Solid State Drive	691852-B21
6G SATA Hot Plug LFF Value Endurance (3.5-inch) Converter Enterprise Value G1 Solid State Drives	
HP 480GB 6G SATA Value Endurance LFF 3.5-in SC Converter ENT Value 3yr Wty G1 Solid State Drive	756660-B21
HP 240GB 6G SATA Value Endurance LFF 3.5-in SC Converter ENT Value 3yr Wty G1 Solid State Drive	756639-B21
HP 120GB 6G SATA Value Endurance LFF 3.5-in SC Converter ENT Value 3yr Wty G1 Solid State Drive	756624-B21
6G SATA Hot Plug LFF (3.5-inch) Enterprise Value Solid State Drives	
HP 800GB 6G SATA Value Endurance LFF 3.5-in SC Enterprise Value 3yr Wty Solid State Drive	718189-B21
HP 600GB 6G SATA Value Endurance LFF 3.5-in SC Converter Enterprise Value 3yr Wty Solid State Drive	739900-B21
HP 480GB 6G SATA Value Endurance LFF 3.5-in SC Enterprise Value 3yr Wty Solid State Drive	718183-B21
HP 300GB 6G SATA Value Endurance LFF 3.5-in SC Converter Enterprise Value 3yr Wty Solid State Drive	739890-B21
HP 240GB 6G SATA Value Endurance LFF 3.5-in SC Enterprise Value 3yr Wty Solid State Drive	718177-B21
HP 1.6TB 6G SATA Value Endurance LFF 3.5-in SC Converter Enterprise Value 3yr Wty Solid State Drive	757342-B21
6G SATA Hot Plug LFF (3.5-inch) Enterprise Light G1 Solid State Drives	
HP 960GB 6G SATA Light Endurance LFF 3.5-in SC Converter ENT Light 3yr Wty G1 Solid State Drive	756604-B21
6G SATA Hot Plug LFF (3.5-inch) Enterprise Boot Solid State Drives	
HP 120GB 6G SATA Value Endurance LFF 3.5-in SC Enterprise Boot 3yr Wty Solid State Drive	718171-B21
HP 80GB 6G SATA Value Endurance LFF 3.5-in SC Enterprise Boot 3yr Wty Solid State Drive	734362-B21
Hard Drive Blank Kits	
HP Large Form Factor Hard Drive Blank Kit	666986-B21
HP Small Form Factor Hard Drive Blank Kit	666987-B21
Hard Drive Kits	
HP ML350 Gen9 SFF Media Cage Kit	726545-B21
HP ML350 Gen9 8LFF Hot Plug Drive Cage Kit	726547-B21
HP ML350 Gen9 LFF Media Cage Kit	726561-B21
HP ML350 Gen9 8SFF Hard Drive Cage Kit	778157-B21
Disk Enclosures	

Core Options

	HP D2600 w/12 4TB 6G SAS 7.2K LFF Dual Port MDL HDD 48TB Bundle	E7W32A
HP Networking	1 Gigabit Ethernet adapters	
	HP Ethernet 1Gb 4-port 331T Adapter	647594-B21
	HP Ethernet 1Gb 2-port 361T Adapter	652497-B21
	HP Ethernet 1Gb 2-port 332T Adapter	615732-B21
	10 Gigabit Ethernet adapters	
	HP Ethernet 10Gb 2-port 560SFP+ Adapter	665249-B21
	HP Ethernet 10Gb 2-port 530T Adapter	656596-B21
	HP Ethernet 10Gb 2-port 530SFP Adapter	652503-B21
	HP Ethernet 10Gb 2-port 561T Adapter	716591-B21

HP InfiniBand	HP InfiniBand FDR 2-port 545QSFP Adapter	702211-B21
----------------------	--	------------

HP Power Supplies	HP Flex Slot Platinum Hot-plug Power supplies	
	HP 500W Flex Slot Platinum Hot Plug Power Supply Kit	720478-B21
	HP 800W Flex Slot Platinum Hot Plug Power Supply Kit	720479-B21
	HP 1400W Flex Slot Platinum Plus Hot Plug Power Supply Kit	720620-B21
	HP ML350 Gen9 X4 RPS Enablement Kit	802988-B21

NOTE: The x4 Redundant Power Supply Enablement (RPS) Kit only supports the HP 800 W and HP 1400 W Flex Slot Platinum hot-plug power supplies. When the x4 RPS kit is installed, at least three power supply modules must be installed in the server.

HP Computation and Graphics Accelerators	HP ML350 Gen9 Graphic Card Support Kit	726565-B21
	NOTE: One Graphic Card Support Kit is required for each computation or graphics accelerator.	
	NVIDIA Quadro K6000 PCI-E Graphics Adapter	730874-B21
	NOTE: A maximum of four of these cards can be selected. Each requires one Graphic Card Support Kit (726565-B21). Note: If this SKU is selected then minimum quantity = 2 of 800W Power Supply Kit (725870-B21) must be selected.	
	HP NVIDIA Quadro K5200 GPU Graphics Accelerator	J0G91A
	NOTE: A maximum of four of these cards can be selected. Each requires one Graphic Card Support Kit (726565-B21).	
	HP NVIDIA Quadro K4200 Graphics Accelerator	J0G90A
	NOTE: A maximum of four of these cards can be selected. Each requires one Graphic Card Support Kit (726565-B21).	
	NVIDIA Tesla K40C 12GB Computational Accelerator	753960-B21
	NOTE: A maximum of four of these cards can be selected. Each requires one Graphic Card Support Kit (726565-B21). Note: If this SKU is selected then minimum quantity = 2 of 800W Power Supply Kit (725870-B21) must be selected.	
HP NVIDIA Quadro K2200 Graphics Accelerator	J0G89A	
NOTE: If more than two Double Wide Graphics options are selected, then HP ML350 Gen9 X4 RPS Enablement Kit must be selected. NOTE: Only the above listed Graphics cards are HP standard supported options in this server. NOTE: The NVIDIA Quadro modules are supported only on 64-bit versions of Linux and Windows operating systems as well as on Virtual Machine client operating systems. The supported bare metal operating systems are RHEL6, SLES 11 and Windows Server 2012 R2. NOTE: Please see the HP Power Advisor for estimated power consumption of your individual system configuration prior to installing GPUs. The HP Power Advisor is located at: www.hp.com/go/hppoweradvisor .		

HP Cooling Options	HP ML350 Gen9 Redundant Fan Kit	725878-B21
	NOTE: 4 fans are included.	

Additional Options

NOTE: Some options may not be integrated at the factory. To ensure only valid configurations are ordered, HP recommends the use of an HP approved configurator. Contact your local sales representative for additional information.

HP Insight Software **HP Insight Control**

HP Insight Control including 1yr 24x7 Technical Support and Updates Single Server License	C6N27A
HP Insight Control including 1yr 24x7 Technical Support and Updates Electronic License	C6N28ABE
HP Insight Control Server Provisioning Media Kit	BD883A
HP Insight Management Media Kit	C6N31A

Embedded Management

HP iLO Advanced

HP iLO Advanced 1 Server License with 3yr 24x7 Tech Support and Updates	BD505A
HP iLO Advanced including 1yr 24x7 Technical Support and Updates E-LTU	E6U59ABE
HP iLO Advanced including 1yr 24x7 Technical Support and Updates Single Server License	512485-B21
HP iLO Advanced including 3yr 24x7 Technical Support and Updates E-LTU	E6U64ABE

High Performance Clusters

HP Cluster Management Utility

HP Insight Cluster Management Utility 1yr 24x7 Flexible License	QL803B
HP Insight Cluster Management Utility 3yr 24x7 Flexible License	BD476A
NOTE: These part numbers can be used to purchase one certificate for multiple licenses and support with a single activation key. Each license is for one node (server). Customer will receive a printed end user license agreement and license entitlement certificate via physical shipment. The license entitlement certificate must be redeemed online in order to obtain a license key. Customer also will receive a support agreement.	
HP Insight Cluster Management Utility Media	BD477A

HP PCIe Workload Accelerator Options

Value Endurance (VE) PCIe Workload Accelerators

HP 6.4TB FH/HL Value Endurance (VE) PCIe Workload Accelerator	763840-B21
HP 3.2TB HH/HL Value Endurance (VE) PCIe Workload Accelerator	763838-B21
HP 1.6TB HH/HL Value Endurance (VE) PCIe Workload Accelerator	763836-B21
HP 1.3TB HH/HL Value Endurance (VE) PCIe Workload Accelerator	763834-B21

Light Endurance (LE) PCIe Workload Accelerators

HP 5.2TB FH/HL Light Endurance (LE) PCIe Workload Accelerator	775672-B21
HP 2.6TB HH/HL Light Endurance (LE) PCIe Workload Accelerator	775670-B21
HP 1.3TB HH/HL Light Endurance (LE) PCIe Workload Accelerator	775668-B21
HP 1.0TB HH/HL Light Endurance (LE) PCIe Workload Accelerator	775666-B21

HP Security

HP Trusted Platform Module Option	488069-B21
HP Security Bezel Kit	660584-B21

NOTE: Rack model only.

NOTE: The TPM (Trusted Platform Module) is a microcontroller chip that can securely store artifacts used to authenticate the server platform. These artifacts can include passwords, certificates and encryption keys. Windows® BitLocker™ Drive Encryption (BitLocker) is a data protection feature available in Windows Server® 2008. BitLocker leverages the enhanced security capabilities of a Trusted Platform Module (TPM) version 1.2. The TPM works with BitLocker to help protect user data and to ensure that a server running Windows Server 2008 has not been tampered with while the system was offline. For more information about TPM, including a white paper, go to: <http://www.hp.com/go/TPM>.

NOTE: ProLiant OS pre-installed units will come with the partition required for TPM deployment.

NOTE: The TPM key is unique to every TPM deployed server and must be retained. Misplacing or losing the key could result in data loss.

HP Storage Controllers

SAS Controllers

HP Smart Array Controllers

Additional Options

HP Smart Array P440ar/2GB FBWC 12Gb 2-ports Int SAS Controller NOTE: Provides support for up to 8 internal SAS/SATA drives without using a PCIe slot. NOTE: Includes the HP Smart Storage Battery.	726736-B21
HP Smart Array P440/4GB FBWC 12Gb 1-port Int SAS Controller NOTE: Provides support for up to 8 internal SAS/SATA drives, consumes 1 PCIe slot.	726821-B21
HP Smart Array P441/4GB FBWC 12Gb 2-ports Ext SAS Controller	726825-B21
HP Smart Array P840/4GB FBWC 12Gb 2-ports Int SAS Controller	726897-B21
HP H240ar 12Gb 2-ports Int Smart Host Bus Adapter NOTE: Provides support for up to 8 internal SAS/SATA drives without using a PCIe slot.	726757-B21
HP H240 12Gb 2-ports Int Smart Host Bus Adapter	726907-B21
HP H241 12Gb 2-ports Ext Smart Host Bus Adapter	726911-B21
HP 12Gb SAS Expander Card for ML350 Gen9 NOTE: The SAS Expander Card Kit cannot support H240ar or P440ar AROC cards. It contains three cables from expander card to HDD backplanes, and one cable from SA or HBA to expander card.	769635-B21
SAS Controller Options	
HP 96W Smart Storage Battery with 145mm Cable for DL/ML/SL Servers	727258-B21
HP Cable Options	
HP ML350 Gen9 Host Bus Adapter Mini-SAS Cable Kit	765648-B21
HP ML350 Gen9 Smart Array Cable Kit	765650-B21
HP ML350 Gen9 Flexible Smart Array Controller Mini-SAS Cable Kit	765652-B21

HP Tape Backup

NOTE: For the complete range of tape drives, autoloaders, libraries and media see: <http://www.hp.com/go/tape>. For hardware and software compatibility of HP tape backup products see: <http://www.hp.com/storage/SPOCK> and <http://www.hp.com/go/ebs>.

Tape Drives

HP StoreEver LTO-6 Ultrium 6650 SAS Internal Tape Drive	EH963A
HP StoreEver LTO-6 Ultrium 6650 SAS External Tape Drive	EH964A
HP StoreEver LTO-6 Ultrium 6250 Internal Tape Drive	EH969A
HP StoreEver 1/8 G2 LTO-6 Ultrium 6250 FC Tape Autoloader	COH19A
HP StoreEver LTO-6 Ultrium 6250 Tape Drive in 1U Rack-mount Kit	COL99A
HP StoreEver LTO-3 Ultrium 920 SAS Internal Tape Drive	EH847B
HP StoreEver LTO-3 Ultrium 920 SAS External Tape Drive	EH848B
HP StoreEver LTO-4 Ultrium 1760 SAS Internal WW Tape Drive	EH919B
HP StoreEver LTO-4 Ultrium 1760 SAS External Tape Drive	EH920B
HP StoreEver LTO-4 Ultrium 1760 SAS (1) in 1U Rack-mount Kit	EH946C
HP StoreEver LTO-5 Ultrium 3000 SAS Internal Tape Drive	EH957B
HP StoreEver LTO-5 Ultrium 3000 SAS External Tape Drive	EH958B
HP StoreEver LTO-5 Ultrium 3000 SAS Tape Drive in 1U Rack-mount	EJ014B
HP StoreEver LTO-5 Ultrium 3280 SAS Internal Tape Drive	EH899B
HP StoreEver LTO-5 Ultrium 3280 SAS External Tape Drive	EH900B
HP StoreEver LTO-5 Ultrium 3280 SAS Tape Drive in 3U Rack-mount	EJ013B
HP StoreEver LTO-6 Ultrium 6250 External Tape Drive	EH970A
HP StoreEver 1U SAS Rack-mount Kit	AE459B
HP StoreEver MSL6480	
HP StoreEver MSL6480 Scalable Expansion Module NOTE: Please see the QuickSpecs for Technical Specifications and additional information: http://h18000.www1.hp.com/products/quickspecs/14604_na/14604_na.html	QU626A
HP StoreEver MSL6480 Scalable Base Module	QU625A
HP MSL2024 0-Drive Tape Library	AK379A
HP MSL4048 0-Drive Tape Library	AK381A

Additional Options

HP MSL Library Extender Kit AQ746A

HP Disk Backup **HP RDX Removable Disk Backup Systems USB**
 HP RDX 2TB USB3.0 Internal Disk Backup System E7X52A
NOTE: For the complete range of RDX drives and media see: <http://www.hp.com/go/rdx>.
 For hardware and software compatibility of HP disk backup products see:
<http://www.hp.com/storage/SPOCK>.

HP Storage Options **NOTE:** The following is a list of all Fibre Channel Host Bus Adapters for Windows and Linux. For detailed compatibility information please see: <http://h18006.www1.hp.com/storage/saninfrastructure/hba.html>.

Emulex Fibre Channel HBAs

HP 81E 8Gb 1-port PCIe Fibre Channel Host Bus Adapter AJ762B
 HP 82E 8Gb 2-port PCIe Fibre Channel Host Bus Adapter AJ763B
 HP StoreFabric SN1100E 16Gb Single Port Fibre Channel Host Bus Adapter C8R38A
 HP StoreFabric SN1100E 16Gb Dual Port Fibre Channel Host Bus Adapter C8R39A

QLogic Fibre Channel HBAs

HP 81Q 8Gb 1-port PCIe Fibre Channel Host Bus Adapter AK344A
 HP 82Q 8Gb 2-port PCIe Fibre Channel Host Bus Adapter AJ764A
 HP StoreFabric SN1000Q 16GB 1-port PCIe Fibre Channel Host Bus Adapter QW971A
 HP StoreFabric SN1000Q 16GB 2-port PCIe Fibre Channel Host Bus Adapter QW972A

Converged Network Adapter

HP StoreFabric CN1100R Dual Port Converged Network Adapter QW990A
 HP StoreFabric CN1200E 10Gb Converged Network Adapter E7Y06A

HP Disk Storage Systems **Disk Enclosures**
 HP D6000 Dual I/O Module Disk Enclosure QQ695A

NOTE: See the [D6000 Disk Enclosure QuickSpecs](http://h18000.www1.hp.com/products/quickspecs/14419_na/14419_na.html) for additional information including configuration steps and additional options needed for a complete solution at:
http://h18000.www1.hp.com/products/quickspecs/14419_na/14419_na.html

HP D6000 w/35 4TB 6G SAS 7.2K LFF Dual Port MDL HDD 140TB Bundle E7W30A
 HP D6000 w/70 4TB 6G SAS 7.2K LFF Dual Port MDL HDD 280TB Bundle E7W31A
 HP D6000 w/35 2TB 6G SAS 7.2K LFF Dual port MDL HDD 70TB Bundle QQ697A
 HP D6000 w/70 2TB 6G SAS 7.2K LFF Dual port MDL HDD 140TB Bundle QQ698A
 HP D6000 w/35 3TB 6G SAS 7.2K LFF Dual port MDL HDD 105TB Bundle QQ699A
 HP D6000 w/70 3TB 6G SAS 7.2K LFF Dual port MDL HDD 210TB Bundle QQ700A

HP Data Center Racks **Rack 10000 G2 series**
 HP 11648 1075mm Pallet Universal Rack H6J87A
 HP 11648 1075mm Shock Universal Rack H6J88A
 HP 11642 1075mm Pallet Universal Rack H6J65A
 HP 11642 1075mm Shock Universal Rack H6J66A
 HP 11642 1200mm Pallet Universal Rack H6J67A
 HP 11642 1200mm Shock Universal Rack H6J68A
 HP 11636 1075mm Pallet Universal Rack H6J77A
 HP 11636 1075mm Shock Universal Rack H6J78A
 HP 11622 G2 1075mm Pallet Universal Rack H6J83A
 HP 11622 G2 1075mm Shock Universal Rack H6J84A
 HP 11614 1075mm Shock Universal Rack H6J82A

NOTE: Please see the [HP 11000 G2 Series Racks QuickSpecs](#) for information on additional racks options and rack specifications.

Additional Options

HP Intelligent Series Rack

HP 647 1075mm Pallet Intelligent Series Rack	BW911A
HP 647 1075mm Shock Intelligent Series Rack	BW912A
HP 647 1200mm Pallet Intelligent Series Rack	BW913A
HP 647 1200mm Shock Intelligent Series Rack	BW914A
HP 642 1075mm Pallet Intelligent Series Rack	BW903A
HP 642 1075mm Shock Intelligent Series Rack	BW904A
HP 642 1200mm Pallet Intelligent Series Rack	BW907A
HP 642 1200mm Shock Intelligent Series Rack	BW908A
HP 636 1075mm Pallet Intelligent Series Rack	BW895A
HP 636 1075mm Shock Intelligent Series Rack	BW896A
HP 842 1075mm Pallet Intelligent Series Rack	BW917A
HP 842 1075mm Shock Intelligent Series Rack	BW918A

NOTE: Please see the [HP Intelligent Series Racks QuickSpecs](#) for information on additional racks options and rack specifications.

HP Value Series Rack

HP V142 1075mm deep Pallet 100 series Rack	AF046A
--	--------

NOTE: Please see the [HP Value Series Rack QuickSpecs](#) for information on additional racks options and rack specifications.

HP Power Distribution Units (PDUs)

HP Basic Power Distribution Unit (bPDU)

HP 4.9kVA 24A High Voltage NA/JP Core Modular Power Distribution Unit	252663-D74
HP 8.3kVA 40A High Voltage NA/JP Core Modular Power Distribution Unit	252663-D75
HP 17.3kVA 48A Three Phase NA/JP Modular Power Distribution Unit	AF511A
HP 3.6kVA 200-240 Volt Detachable C20 Input (12xC13) WW Basic PDU	H5M56A
HP 4.9kVA 208 Volt L6-30 Input (20xC13) NA/JP Basic PDU	H5M58A

NOTE: To learn more about [HP Basic Power Distribution Units \(bPDU\)](#), please visit the [HP website at http://www.hp.com/go/pdu](http://www.hp.com/go/pdu).

HP Monitored Power Distribution Units (mPDU)

HP 2.8kVA 120 Volt L5-30 Input (12xNEMA 5-20R)NA/JP Monitored PDU	D9N43A
HP 3.6kVA 200-240 Volt Detachable C20 Input (16xC13) WW Monitored PDU	D9N45A
HP 4.9kVA 208 Volt L6-30 Input (20xC13/4xC19) NA/JP Monitored PDU	D9N47A
HP 17.3kVA 208 Volt IEC309 60A 3-Phase Input (12xC13/12xC19) NA/JP Monitored PDU	D9N59A

NOTE: Please see the [HP Monitored Power Distribution Units QuickSpecs](#) for information on additional options and product specifications.

HP Intelligent Power Distribution Units (iPDU)

HP 4.9kVA 24A Single Phase NA/JP Core Intelligent Modular Power Distribution Unit	AF520A
HP 8.3kVA 40A Single Phase NA/JP Core Intelligent Modular Power Distribution Unit	AF521A
HP 8.6kVA 24A Three Phase NA/JP Core Intelligent Modular Power Distribution Unit	AF522A
HP 17.3kVA 48A Three Phase NA/JP Core Intelligent Modular Power Distribution Unit	AF523A
HP 17.3kVA 48A 208V Three Phase 12 Outlet Core NA/JP Intelligent Power Distribution Unit	AF535A
HP 4.9kVA 24A Single Phase NA/JP Intelligent Modular Power Distribution Kit	AF531A
HP 8.6kVA 24A Three Phase NA/JP Intelligent Modular Power Distribution Kit	AF532A

NOTE: Please see the [HP Intelligent Power Distribution Units QuickSpecs](#) for information on additional options and product specifications.

HP Rack Mount Consoles, KVM Switches, and Keyboards

HP Location Discovery Services

HP 36U Location Discovery Kit	BW945A
HP 42U Location Discovery Kit	BW946A
HP 47U Location Discovery Kit	BW947A

Rail Kits

Additional Options

HP ML350 Gen9 Tower to Rack Conversion Kit	726567-B21
HP Rack Mount Consoles	
HP TFT7600 G2 KVM Console Rackmount Keyboard US Monitor	AZ870A
NOTE: Please see the HP Rack Console QuickSpecs for information on additional options and product specifications.	
HP KVM Switches	
HP 1x1Ex8 KVM IP Console Switch G2 with Virtual Media CAC Software	AF620A
HP 2x1Ex16 KVM IP Console Switch G2 with Virtual Media CAC Software	AF621A
HP Server Console 0x2x8 Port Analog Switch	AF616A
HP Server Console 0x2x16 Port Analog Switch	AF617A
HP 0x2x16 KVM Server Console Switch G2 with Virtual Media CAC Software	AF618A
HP 1x4 USB/PS2 KVM Console Switch	AF611A
NOTE: To learn more, please visit the HP KVM Switches web page .	
HP USB Keyboard and Mouse	
HP USB BFR with PVC Free US Keyboard/Mouse Kit	631341-B21
NOTE: Please see the HP USB Keyboard and Mouse QuickSpecs for information on additional options and product specifications.	
Micro SD Options	
HP 32GB microSD Enterprise Mainstream Flash Media Kit	700139-B21
HP 8GB microSD Enterprise Mainstream Flash Media Kit	726116-B21
HP 8GB USB Enterprise Mainstream Flash Media Drive Key Kit	737953-B21

HP Uninterruptible Power Systems (UPS)	HP Tower UPS	
	HP T1500 G3 1400VA NA Tower Uninterruptible Power System	AF450A
	HP T1000 G3 1000VA NA Tower Uninterruptible Power System	AF448A
	HP Rack-mountable UPS	
	HP R/T3000 G2 2U L530 Low Voltage NA/JP Uninterruptible Power System	AF466A
NOTE: To learn more, please visit the HP Uninterruptible Power Systems (UPS) web page .		

HP Care Pack Services	Installation & Start-up Services	
	HP Install ProLiant ML350(p) Service	U4522E
	HP Startup ProLiant ML350(p) Service	U4523E
	Proactive Care	
	HP 3 year 24x7 ML350 Gen9 Proactive Care Service	U7BG4E
	HP 3 year Call to Repair ML350 Gen9 Proactive Care Service	U7BH0E
	HP 3 year 24x7 with Defective Media Retention ML350 Gen9 Proactive Care Service	U7BG5E
	HP 3 year 24x7 with Comprehensive Defective Material Retention ML350 Gen9 Proactive Care Service	U7BG6E
	HP 3 year Call to Repair with Defective Media Retention ML350 Gen9 Proactive Care Service	U7BH1E
	HP 3 year CTR with Comprehensive Defective Material Retention ML350 Gen9 Proactive Care Service	U7BH2E

Memory

Memory Subsystem Architecture

Each Intel® Xeon® E5-2600v3 family processor socket contains four memory channels per installed processor with three DIMMs per channel for a total of twelve (12) DIMMs or a grand total of twenty-four (24) DIMMs for the server.

Memory Population guidelines

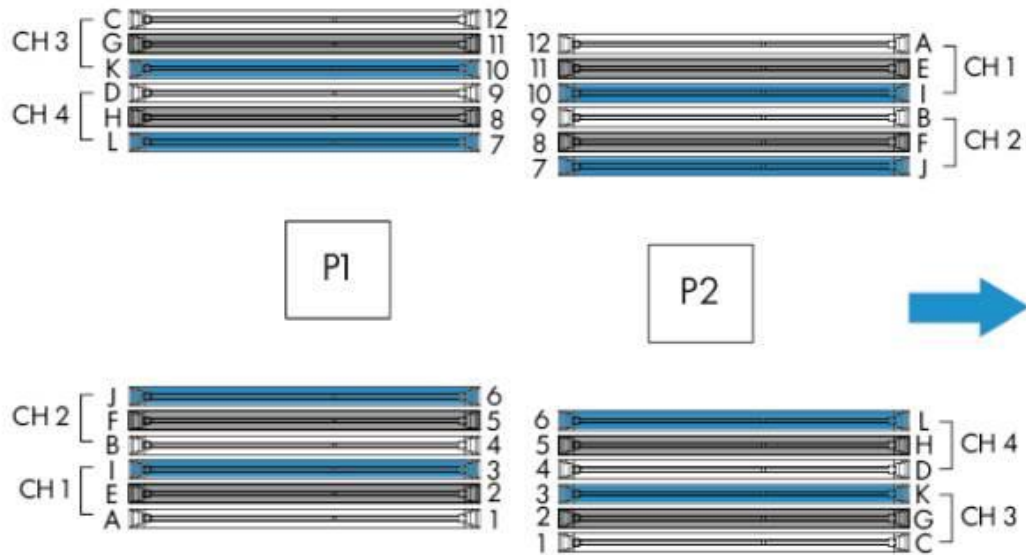

DIMM population order												
	1st slot of channel			2nd slot of channel			3rd slot of channel					
	A	B	C	D	E	F	G	H	I	J	K	L
Number of DIMMs to install	4											
	8											
	12											

General Memory Population Rules and Guidelines:

- Install DIMMs only if the corresponding processor is installed.
- If only one processor is installed in a two processor system, only half of the DIMM slots are available. To maximize performance, it is recommended to balance the total memory capacity between all installed processors and load the channels similarly whenever possible.
- When two processors are installed, balance the DIMMs across the two processors.
- White DIMM slots denote the first slot to be populated in a channel. Place the DIMMs with the highest number of ranks in the white slot when mixing DIMMs of different ranks on the same channel.
- Do not mix RDIMMs or LRDIMMs.
- Quad rank RDIMMs are not supported in HP ProLiant ML350 Gen9 servers.
- Quad rank LRDIMMs are capable of up to three DIMMs per channel.
- RDIMMs operating at 1.2V.
- DIMMs of different speeds may be mixed in any order; the server will select a common optimal speed.
- The maximum memory speed is a function of the memory type, memory configuration, and processor model.
- The maximum memory capacity is a function of the memory type and number of installed processors.
- To realize the performance memory capabilities listed in this document, HP SmartMemory is required.
- There are four (4) channels per processor; eight (8) channels per server.
- There are three (3) DIMM slots for each memory channel; twenty-four (24) total slots.

Memory

Memory channels 1 and 3 consists of the three (3) DIMMs that are furthest from the processor.
Memory channel 2 and 4 consists of the three (3) DIMMs that are closest to the processor.

Intel Gen9 Supported Memory Bandwidth for HP ProLiant Gen9 Intel® Xeon® E5-2600v3 Series Processor Family

Memory Bandwidth and Capacity					
[DIMM Type]	Registered Dimms (RDIMMs)			Load Reduced (LRDIMMs)	Load Reduced (LRDIMMs)
DIMM Rank	Single Rank		Dual Rank		Quad Rank
DIMM Capacity	4GB	8GB	16GB		32GB
Voltage	Std Voltage 1.2V				
SLOTS THAT CAN BE POPULATED					
24 slot servers	24				
MAXIMUM CAPACITY (GB)					
	96	192	384		768
1 DIMM Per Channel	2133				
2 DIMM Per Channel	2133				
3 DIMM Per Channel	1600	1600	1600	1600	

DIMM slot and configuration diagram

DIMM slot and configuration diagrams

- Population order; start with "A" first, "B" second, "C" third, etc.
- When one processor is installed, install DIMMs in sequential alphabetic order: A, B, C, D, E, F ...
- When two processors are installed, install DIMMs in sequential alphabetic order: CPU1-A, CPU2-A, CPU1-B, CPU2-B, CPU1-C, CPU2-C

		CPU 1		CPU 2				
		Slot #	population order	Slot #	population order			
Chnl 1	1	A		1	C	Chnl 4		
	2	E		2	G			
	3	I		3	K			
		CPU 1		CPU 2				
		Slot #	population order	Slot #	population order			
Chnl 2	4	B		4	D	Chnl 3		
	5	F		5	H			
	6	J		6	L			
		CPU 1		CPU 2				
		Slot #	population order	Slot #	population order			
Chnl 3	7	L		7	J	Chnl 2		
	8	H		8	F			
	9	D		9	B			
		CPU 1		CPU 2				
		Slot #	population order	Slot #	population order			

Memory

Chnl 4	10	K	10	I	Chnl 1
	11	G	11	E	
	12	C	12	A	

Memory Speed by Processor Model

Processor Models	Supported Memory Speeds
E5-2609v3, E5-2603v3,	1600MHz
E5-2640v3, E5-2630v3, E5-2620v3, E5-2630Lv3, E5-2623v3,	1866MHz
E5-2637v3, E5-2690v3, E5-2680v3, E5-2670v3, E5-2660v3, E5-2650v3, E5-2650Lv3, E5-2697v3, E5-2695v3, E5-2667v3, E5-2643v3, E5-2683v3, E5-2699v3, E5-2698v3,	2133MHz

Standard and Maximum Memory Capacity (Pre-configured Models)

Pre-Configured Models	Standard Memory	Maximum Memory Plus Optional Memory	Standard Memory Replaced with Optional Memory
E5-2609v3,	8GB (1x8GB)	376GB (23x16GB, 1x8GB)	768GB (24x32GB)
E5-2620v3,	16GB (1x16GB)	384GB (23x16GB, 1x16GB)	768GB (24x32GB)
E5-2630v3, E5-2650v3,	32GB (2x16GB)	384GB (22x16GB, 2x16GB)	768GB (24x32GB)

DDR4 memory options part number decoder

NOTE: Capacity references are rounded to the common gigabyte (GB) values.

- 2GB = 2,048MB
- 4GB = 4,096MB
- 8GB = 8,192MB
- 16GB = 16,384MB
- 32GB = 32,768MB
- 64GB = 65,536MB

HP gggggg eRxff DDR4 wwwwm a bb-ccd Kit

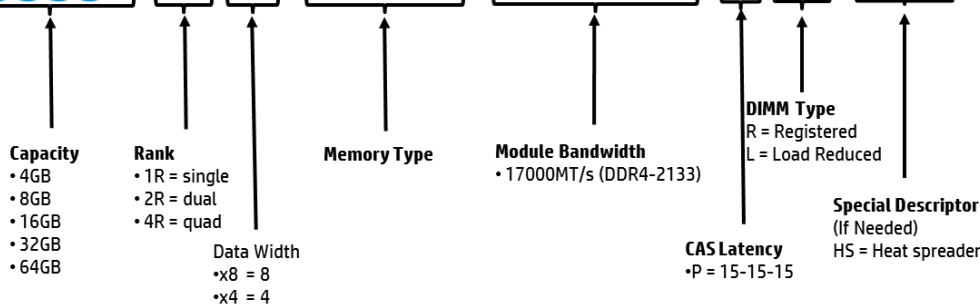

Storage

48 SFF hot-plug drive model

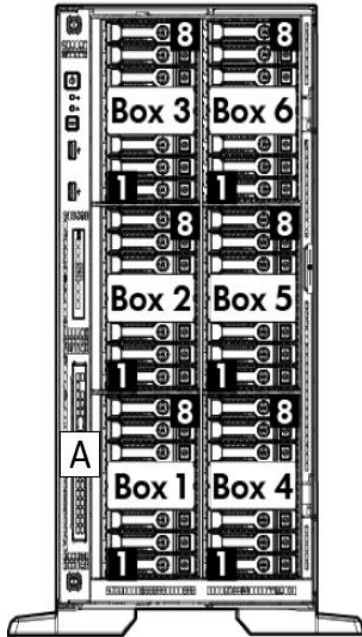

- A Optional Slim DVD-ROM/DVD-RW
- 1-8 8 x SFF SATA/SAS/SSD Hot Pluggable Hard Drive Bays

24 LFF hot-plug drive model

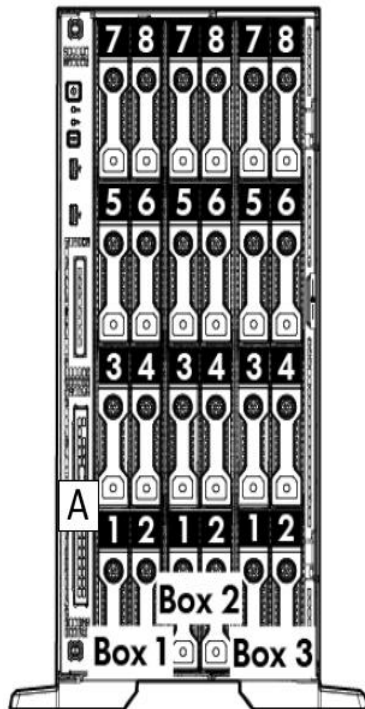

- A Optional Slim DVD-ROM/DVD-RW
- 1-8 8 x LFF SATA/SAS/SSD Hot Pluggable Hard Drive Bays

Technical Specifications

System Unit	Tower Dimensions	18.27(H) x 8.62(W) x 30.28(D) in (46.4 x 21.9 x 76.9 cm)	
	Rack Dimensions	8.58(H) x 17.51(W) x 29.37(D) in (21.8 x 44.5 x 74.6 cm)	
	Tower Weight	Minimum:	66.14lb(30kg)
		Maximum:	121.30lb (55kg)
	Rack Weight	Minimum:	57.3lb(26kg)
		Maximum:	112.4lb(51kg)
	Input Requirements	Range Line Voltage	100 to 120 VAC 200 to 240 VAC
		BTU Rating	Maximum For 1400W Power Supply: 5459 BTU/hr (at 200 VAC), 5459 BTU/hr (at 240 VAC), 5459 BTU/hr (at 240 VAC) for China Only For 800W Power Supply: 3207 BTU/hr (at 100 VAC), 3071 BTU/hr (at 200 VAC), 3112 BTU/hr (at 240 VAC) for China Only For 500W Power Supply: 1979 BTU/hr (at 100 VAC), 1911 BTU/hr (at 200 VAC), 1965 BTU/hr (at 240 VAC) for China Only
	Power Supply Output	Rated Steady-State Power	For 1400W Power Supply: 1400W (at 100 VAC), 1400W (at 240 VAC), 1400W (at 240 VAC) For 800W Power Supply: 800W (at 100 VAC), 800W (at 240 VAC), 800W (at 240 VAC) input for China only For 500W Power Supply: 500W (at 100 VAC), 500W (at 240 VAC), 500W (at 240 VAC) input for China only
		Maximum Peak Power	For 1400W Power Supply: 1400W (at 100 to 127 VAC), 1400W (at 200 to 240 1VAC), 1400W (at 240 VAC) input for China only For 800W Power Supply: 800W (at 100 to 127 VAC), 800W (at 200 to 240 1VAC), 800W (at 240 VAC) input for China only For 500W Power Supply: 500W (at 100 to 127 VAC), 500W (at 200 to 240 VAC), 500W (at 240 VAC) input for China only
		System Inlet Temperature	Standard Operating Support 10° to 35°C (50° to 95°F) at sea level with an altitude derating of 1.0°C per every 305 m (1.8°F per every 1000 ft) above sea level to a maximum of 3050 m (10,000 ft), no direct sustained sunlight. Maximum rate of change is 20°C/hr (36°F/hr). The upper limit and rate of change may be limited by the type and number of options installed. For approved hardware configurations, the supported system inlet range is extended to be: 5° to 40°C (41° to 104°F) at sea level with an altitude derating of 1.0°C per every 175 m (1.8°F per every 574 ft) above 900 m (2953 ft) to a maximum of 3050 m (10,000 ft). The approved hardware configurations for this system are listed at the URL: http://www.hp.com/servers/ashrae . For approved hardware configurations, the supported system inlet range is extended to be: 5° to 45°C (41° to 113°F) at sea level with an altitude derating of 1.0°C per every 125 m (1.8°F per every 410 ft) above 900 m (2953 ft) to a maximum of 3050 m (10,000 ft). The approved hardware configurations for this system are listed at the URL: http://www.hp.com/servers/ashrae . Extended Ambient Operating Support Non-operating -30° to 60°C (-22° to 140°F). Maximum rate of change is 20°C/hr (36°F/hr).
	Relative Humidity	Operating	Minimum to be the higher (more moisture) of -12°C (10.4°F) dew point or 8% relative humidity. Maximum to be the lower (less moisture) of 24°C (75.2°F) dew point or 90% relative humidity.
		Non-operating	5 to 95% relative humidity (Rh), 38.7°C (101.7°F) maximum wet bulb temperature, non-condensing.
	Altitude	Operating	3050 m (10,000 ft). This value may be limited by the type and number of options installed. Maximum allowable altitude change rate is 457 m/min (1500 ft/min).

Technical Specifications

	Non-operating	9144 m (30,000 ft). Maximum allowable altitude change rate is 457 m/min (1500 ft/min).
Acoustic Noise		Listed are the declared A-Weighted sound power levels (LWAd) and declared average bystander position A-Weighted sound pressure levels (LpAm) when the product is operating in a 23°C ambient environment. Noise emissions were measured in accordance with ISO 7779 (ECMA 74) and declared in accordance with ISO 9296 (ECMA 109).
		Idle
	L WAd	3.6 Bels (1P LFF Entry) 3.5 Bels (1P SFF Base) 3.6 Bels (2P SFF E-star Rack) 3.4 Bels (2P SFF E-star Tower)
	L pAm	21 dBA (1P LFF Entry) 21 dBA (1P SFF Base) 20 dBA (2P SFF E-star Rack) 19 dBA (2P SFF E-star Tower)
		Operating
	L WAd	3.7 Bels (1P LFF Entry) 3.6 Bels (1P SFF Base) 4.5 Bels (2P SFF E-star Rack) 4.5 Bels (2P SFF E-star Rack)
	L pAm	21 dBA (1P LFF Entry) 22 dBA (1P SFF Entry) 28 dBA (2P SFF E-star Rack) 28 dBA (2P SFF E-star Tower)
		NOTE: Configurations tested for 1P LFF Entry models included two (2) 500GB LFF SATA Midline HDD and Windows 2012 Enterprise 64-bit.
		NOTE: Configurations tested for 1P and 2P SFF models included two (2) 500GB SFF SATA Midline HDD and Windows 2012 Enterprise 64-bit.
		NOTE: The Listed sound levels apply to standard shipping configurations. Additional options may result in increased sound levels.
Emissions Classification	FCC Rating	Class A
	Normative Standards	CISPR 22; EN55022; EN55024; FCC CFR 47, Pt 15; ICES-003; CNS13438; GB9254; K22;K24; EN 61000-3-2; EN 61000-3-3; EN 60950-1; IEC 60950-1
		NOTE: Product conformance to cited product specifications is based on sample (type) testing, evaluation, or assessment. This product or family of products is eligible to bear the appropriate compliance logos and statements.

HP Dynamic Smart Array B140i Controller	Number of PCI links	Four
	PCI link rate	4 Gb/s
	Storage protocol support	SATA
	SAS/SATA peak data transfer rate	6 Gb/s
	Number of SAS/SATA links	10 links
	SAS/SATA connectivity	2x4 connectors; 2x1 connectors
	Expander support	No
	Drives supported (max)	Up to 10 Internal Drives
	RAID support	0, 1, 10, 5 SATA
	Software management	HP SSA, SMH, SIM
	Warranty	Server warranty

Technical Specifications

HP Secure Encryption license	Not Supported
HP SmartCache License	Not Supported
HP Smart Storage Administrator	Supported

HP Ethernet 1Gb 4-port 331i Adapter	Network Interface	10Base-T/100Base-TX/1000Base-TX	
	Compatibility	IEEE 802.3 10Base-T IEEE 802.3ab 1000Base-T IEEE 802.3u 100Base-TX	
	Data Transfer Method	PCI Express, two lanes (x2)	
	Controller	BCM5719	
	Network Transfer Rate	10Base-T (Half-Duplex)	10 Mb/s per port, 40 Mb/s combined
		10Base-T (Full-Duplex)	20 Mb/s per port, 80 Mb/s combined
		100Base-TX (Half-Duplex)	100 Mb/s per port, 400 Mb/s combined
		100Base-TX (Full-Duplex)	200 Mb/s per port, 800 Mb/s combined
		100Base-TX (Half-Duplex)	1000Mb/s per port, 4000 Mb/s combined
		100Base-TX (Full-Duplex)	2000Mb/s per port, 8000 Mb/s combined
Connector	RJ-45		
Cable Support	10 Base-T	Categories 3, 4 or 5 UTP; up to 328 ft (100 m)	
	10/100/1000 Base-TX	Category 5 or higher UTP; up to 328 ft (100 m)	

Environment-friendly Products and Approach

End-of-life Management and Recycling

Hewlett-Packard offers end-of-life HP product return, trade-in, and recycling programs in many geographic areas. For trade-in information, please go to: <http://www.hp.com/go/green>. To recycle your product, please go to: <http://www.hp.com/go/green> or contact your nearest HP sales office. Products returned to HP will be recycled, recovered or disposed of in a responsible manner.

The EU WEEE directive (2002/95/EC) requires manufacturers to provide treatment information for each product type for use by treatment facilities. This information (product disassembly instructions) is posted on the Hewlett Packard web site at: <http://www.hp.com/go/green>. These instructions may be used by recyclers and other WEEE treatment facilities as well as HP OEM customers who integrate and re-sell HP equipment.



hp.com/qref/ml350gen9

Summary of Changes

Date	Version History	Action	Description of Change
12/01/2014	From Version 3 to 4	Changed	Changes made throughout the entire QuickSpecs.
10/13/2014	From Version 2 to 3	Added	6G SATA Enterprise Value G1 Solid State Drives were added to Core Option section. High Performance Clusters, HP PCIe Workload Accelerator Options, HP USB and SD options, and HP Care Pack Services were added to the Additional Options section.
		Changed	Standard Features, Optional Features, Core Options, Additional Options, and Memory sections were revised.
9/19/2014	From Version 1 to 2	Changed	Changes made throughout the entire QuickSpecs.

© Copyright 2014 Hewlett-Packard Development Company, L.P.

The information contained herein is subject to change without notice. The only warranties for HP products and services are set forth in the express warranty statements accompanying such products and services. Nothing herein should be construed as constituting an additional warranty. HP shall not be liable for technical or editorial errors or omissions contained herein.

Intel® and Xeon® are registered trademarks of Intel Corporation in the U.S. and other countries.

Microsoft®, Windows®, and Windows Server® are U.S. registered trademarks of the Microsoft group of companies.

For hard drives, 1GB = 1 billion bytes. Actual formatted capacity is less